

RESEARCH ARTICLE

The mechanics of air breathing in gray tree frog tadpoles, *Hyla versicolor* (Anura: Hylidae)

Jackson R. Phillips*, Amanda E. Hewes and Kurt Schwenk

ABSTRACT

We describe air-breathing mechanics in gray tree frog tadpoles (*Hyla versicolor*). We found that *H. versicolor* tadpoles breathe by 'bubble-sucking', a breathing mode typically employed by tadpoles too small to break the water's surface tension, in which a bubble is drawn into the buccal cavity and compressed into the lungs. In most tadpoles, bubble-sucking is replaced by breach breathing (breaking the surface to access air) at larger body sizes. In contrast, *H. versicolor* tadpoles bubble-suck throughout the larval period, despite reaching body sizes at which breaching is possible. *Hyla versicolor* tadpoles exhibit two bubble-sucking behaviors: 'single bubble-sucking', previously described in other tadpole species, is characterized by a single suction event followed by a compression phase to fill the lungs; 'double bubble-sucking' is a novel, apparently derived form of bubble-sucking that adds a second suction event. *Hyla versicolor* tadpoles transition from single bubble-sucking to double bubble-sucking at approximately 5.7 mm snout–vent length (SVL), which corresponds to a period of rapid lung maturation when they transition from low to high vascularization (6.0 mm SVL). Functional, behavioral and morphological evidence suggests that double bubble-sucking increases the efficiency of pulmonary gas exchange by separating expired, deoxygenated air from freshly inspired air to prevent mixing. *Hyla versicolor*, and possibly other hylid tadpoles, may have specialized for bubble-sucking in order to take advantage of this increased efficiency. Single and double bubble-sucking represent two- and four-stroke ventilation systems, which we discuss in the context of other anamniote air-breathing mechanisms.

KEY WORDS: Anuran larvae, Gas exchange, Development, Functional morphology, Lungs

INTRODUCTION

It is popularly believed that lungs are exclusively a feature of terrestrial organisms such as reptiles and mammals, whereas fish and other aquatic animals breathe solely with gills. Accordingly, the origin of vertebrate lungs is often mistakenly linked to the origin of terrestrial tetrapods. While it is true that lungs allowed stem tetrapods to invade the land, it is now apparent that their origin preceded the evolution of terrestrial vertebrates by millions of years (Brainerd et al., 1993; Brainerd and Dumka, 1995; Brainerd, 2015; Liem, 1988; Perry et al., 2001; Perry and Sander, 2004). If lungs and air breathing arose in ancestral fishes, then a functional and

evolutionary understanding of air breathing is best sought in the context of aquatic life. Anuran larvae ('tadpoles') may be useful models in this regard because, like ancestral fishes, they are obligate aquatic organisms possessing both functional lungs and gills. Furthermore, tadpoles undergo a metamorphosis during which they transition into terrestrial adults, an ontogenetic process that mimics, if not actually recapitulates, the water–land evolutionary transition.

It was historically believed that tadpoles lacked lungs throughout most of the larval period, relying on gills and cutaneous respiration for gas exchange, until lungs and air breathing developed during metamorphosis in preparation for adult life (e.g. St. Mivart, 1880; Holmes, 1930; Rugh, 1951). Just as it is now understood that lungs preceded the transition to terrestrial life in tetrapods, it is now widely known that the development of lungs in many tadpoles occurs well before metamorphosis (Weisz, 1945; Feder, 1984; Ultsch et al., 1999; Wells, 2007). Indeed, a recent study of five species representing three families found that air-breathing behavior and lung inflation occurred within a few days of hatching (Schwenk and Phillips, 2020).

Nearly all work dealing with air breathing in tadpoles has focused on the respiratory physiology of two model taxa, *Xenopus* and *Rana* (e.g. Feder and Wassersug, 1984; Wassersug and Seibert, 1975; West and Burggren, 1982). Generally, these studies have found that lungs and air breathing are employed throughout larval life, but are especially important for survival in hypoxic waters. Several studies have suggested that lungs also play a role in modulating buoyancy (e.g. Gee and Waldick, 1995). With the exception of one study (Wassersug and Yamashita, 2000), the mechanics of air breathing have been virtually unstudied. Recently, however, Schwenk and Phillips (2020) examined air-breathing mechanics in tadpoles of five frog species. They found that small size and weak swimming prevented young tadpoles from breaking through the water's surface tension to breathe air. Nevertheless, the tadpoles were able to access air using a breathing mechanism they called 'bubble-sucking', which does not require breaching the water's surface. During bubble-sucking, a tadpole attaches its mouth to the underside of the water's surface and expands the buccal cavity, drawing a bubble of air down from the surface into the mouth. The bubble is then 'pinched off' and compressed by elevation of the buccal floor, forcing air into the lungs. Excess air is then expelled. As most tadpoles grew, increasing in mass and swimming speed, they transitioned from bubble-sucking to breaching the surface to breathe ('breach breathing').

Among the five species studied by Schwenk and Phillips (2020), the tadpoles of one species never transitioned to breach breathing. Gray tree frog [*Hyla versicolor* LeConte 1825 (Hylidae)] tadpoles continued to bubble-suck throughout the larval period and well into metamorphic climax, despite growing large and fast enough to breach the surface. Furthermore, *H. versicolor* tadpoles were often observed to use two, and occasionally three, separate suction events during a bubble-suck rather than the typical single

Department of Ecology and Evolutionary Biology, University of Connecticut, Storrs, CT 06269, USA.

*Author for correspondence (jackson.phillips@uconn.edu)

 J.R.P., 0000-0001-9831-6609; A.E.H., 0000-0001-7706-633X; K.S., 0000-0002-0767-3940

Received 29 November 2019; Accepted 2 February 2020

suction event of other species. The other hylid species included in the study, *Pseudacris crucifer*, also exhibited two suction events during bubble-sucking, but like other tadpoles, it often breached to breathe at larger body sizes. Here, we describe air-breathing behavior in *Hyla versicolor* tadpoles, focusing on the mechanics of breathing throughout larval ontogeny and the functional significance of multiple suction events during bubble-sucking. We compare our results with bubble-sucking in other amphibian species and with breathing in non-amniote vertebrates, generally, and consider the evolution of bubble-sucking behavior.

MATERIALS AND METHODS

Animals

We collected clutches of *H. versicolor* eggs laid in small, artificial ponds by wild individuals (Connecticut scientific collecting permit no. 2023001). The ponds consisted of either plastic, 5 gallon (~19 l) buckets partially filled with water or abandoned planters filled with shallow water and vegetation. The ponds were located in an open field adjacent to woodland in Storrs, CT, USA. Eggs were returned to the lab and reared in 38 l glass aquaria filled half-way and kept at room temperature on a 12 h:12 h light:dark cycle. After tadpoles had consumed the egg mass and their remaining yolk, they were provided with chopped, boiled green lettuce *ad libitum*. Water was changed whenever it became turbid using either untreated well water or aged tap water (to avoid chlorine toxicity).

For anatomical studies, tadpoles were killed via anesthetic overdose using a bath of 10% benzocaine ointment dissolved in water (AVMA, 2013). They were then rinsed in deionized water and either dissected immediately under a dissecting microscope or fixed in 10% formalin solution for at least 1 week before being transferred to 70% ethanol for preservation. Dissections of fresh (unfixed) specimens allowed visualization of the lungs while still inflated with air. All live animal work was approved by the University of Connecticut Institutional Animal Care and Use Committee (protocol no. A18-032).

High-speed videography

We used an Edgertronic SC1 monochrome camera fitted with a Nikon 105 mm, f/2.8 macro lens to obtain close-up, high-speed video of tadpoles air breathing. For videography, tadpoles were placed in a small glass or plastic chamber that allowed unrestricted motion. Tadpoles were filmed throughout the larval period, from the first air breaths a few days post-hatching through metamorphosis 2 months later (~3 to ≥ 15 mm snout-vent length, SVL). A millimeter scale was placed within the field-of-view of the video frame on the inner surface of the filming chamber's front pane. Illumination was provided by three banks of continuous (video) LED lights (500 LED lights, ikan[®], Houston, TX, USA), plus supplemental lighting as needed. Videos were taken at 300–1000 frames s⁻¹.

Air-breathing sequences were analyzed and quantified using the freeware program Tracker[®] v.4.11.0 (Brown, 2017). The program was calibrated using the millimeter scale within the frame of each video so that tadpole SVL could be measured. Each bubble-suck was scored by the number of suction events observed within a single breathing cycle. We identified several discrete, kinematic phases that occur during a breathing cycle: attachment, suction, lung emptying, compression, lung filling and bubble release. Designating 'attachment' as time zero, we used Tracker[®] to calculate the time to initiation of each kinematic event and its duration in seconds.

Paraffin histology and analysis of lung vasculature

Nineteen individuals, ranging from 3.3 to 12 mm SVL, were embedded in 100% paraffin and sectioned in the frontal plane at 6–10 μ m to examine lung structure and vascularization. Sections were stained with either Harris' hematoxylin and eosin, or Weigert iron hematoxylin and Picro-Ponceau (modified slightly from Presnell and Schreiber, 1997). The latter stain provided better visualization of blood vessels for quantification of lung vascularization.

We selected three individual sections per tadpole for analysis of lung vascularization. We standardized section selection for each individual as much as possible: we identified whichever lung (left or right) appeared to provide better quality sections and starting with the dorsal-most section in which lung tissue appeared, we counted all sections through that lung, moving ventrally, until the initially ovoid lung section became divided antero-posteriorly into two separate parts (owing to ventral curvature of the lungs). We examined lung sections at 25%, 50% and 75% of the total number of counted sections. If a section so identified was damaged, the nearest undamaged section was used. Each selected section was examined under a microscope at 100–400 \times magnification and the number of blood vessels occurring along the lung's margins and septae was counted. Blood vessel counts from the three sections were averaged to provide a single estimate for each individual.

Quantitative and statistical analyses

We observed bubble-sucking behavior in hundreds of videos. Only a fraction of these were suitable for quantitative analysis. Furthermore, individuals were maintained and filmed in groups and not individually marked. We therefore took additional steps to avoid pseudoreplication in our analyses. We examined every video with great care, using individual identifiers such as size and pattern to rule out the possibility that multiple breathing bouts were performed by the same individual. If the breathing individuals in different videos could not be positively assessed as unique, then one of the videos was removed from the analysis. Therefore, each data point is indicative not only of a breathing bout but also of an individual. In those videos initially selected for statistical analysis, we rarely (<10 times) observed the same individual perform both breathing modes. To avoid any bias by assigning a single mode to such a tadpole, we excluded these individuals from all statistical analyses. Our initial dataset included 164 individuals assigned to one of two breathing modes (Table 1).

Within each breathing bout, we identified several discrete kinematic phases: attachment, suction, compression, lung filling and lung emptying. However, lung filling and lung emptying could only be visualized in a fraction of the videos in the initial dataset. Therefore, for quantitative analysis of breathing kinematics, we used a reduced dataset of 69 individuals (Table 2). All statistical analyses were performed in R v.3.4.3 (<https://www.R-project.org/>).

We tested whether the duration of discrete kinematic phases of air breathing changed across ontogeny within breathing modes by regressing the average duration of each kinematic phase against body length and assessing significance using *F*-statistics.

Table 1. Frequency of different breathing modes in *Hyla versicolor* tadpoles

Breathing mode	No. of individuals	% Total
Single bubble-suck	39	23.5
Double bubble-suck	125	75.3
Triple bubble-suck	2	1.2
Breach breathing	0	0

Table 2. Duration of kinematic phases in single and double bubble-sucking

Kinematic phase	Duration (s)	
	Single bubble-sucking (N=28)	Double bubble-sucking (N=41)
Suction	0.070±0.012	–
Suction I	–	0.112±0.014
Suction II	–	0.067±0.016
Compression	0.374±0.121	0.333±0.076
Lung filling	0.084±0.008	0.027±0.020
Lung emptying	Not observed	0.008±0.005
Total breath	0.445±0.135	0.518±0.080

Duration data are given as means±s.d.

We used two-sample *t*-tests to assess whether the kinematic events of two of the observed breathing modes – single bubble-sucks (SBS) and double bubble-sucks (DBS) – differed. We compared the durations of similar phases in each of the two breathing modes using several pairwise comparisons: (1) suction in SBS (S_{SBS}) versus suction I in DBS (SI_{DBS}); (2) S_{SBS} versus suction II in DBS (SII_{DBS}); (3) compression in SBS (C_{SBS}) versus compression in DBS (C_{DBS}); and (4) lung filling in SBS (LF_{SBS}) versus lung filling in DBS (LF_{DBS}). It is possible, however, that these analyses could be skewed by body size effects, as SBS and DBS did not occur evenly across ontogeny. To correct for this, we used a non-parametric analysis of covariance with the R package ‘sm’ (<http://www.stats.gla.ac.uk/~adrian/sm>) to test whether the duration of kinematic events in SBS and DBS differed if body size was included as a covariate in the analysis. We used the function ‘sm.ancova’ under the ‘equal’ model to test the effects of SVL and breathing mode on the duration of a given phase. We then used a Bonferroni correction to adjust *P*-values, which were significant for those phases that differed between the two modes.

We examined the distribution of the two main breathing modes through the larval period using a combination of methods. First, we examined histograms of the two breathing modes as a function of body length (SVL) in order to explore the data. This exercise indicated the presence of a size-related behavioral shift, which we then tested using logistic regression. We used a binomial GLM of breathing mode as a function of body length, which was scaled and centered prior to modeling. We anticipated that our model would reveal an ontogenetic transition from one breathing mode to the other, which we identified as the body length at which the model predicted an equal probability of performing either behavior.

We examined the ontogeny of lung morphology using linear modeling. A preliminary examination of the relationship between average blood vessel number and body length suggested that the number of blood vessels increased sharply partway through development. We determined that this dramatic increase in vessel number might best be modeled by splitting the data into two size classes and modeling each separately. We used the R packages ‘strucchange’ v.1.5-1 (Zeileis et al., 2002) and ‘breakpoints’ v.1.5-1 (Zeileis et al., 2003) to find the body length most likely to represent a transition point between size classes. This was accomplished with a breakpoints analysis that allowed the data to be split at any body size, and then optimized the breakpoint using maximum likelihood. We then regressed the average blood vessel number over SVL within each size class and compared the summed AIC scores of the two models with the AIC score of a single, linear model fit to the entire dataset to confirm that the presence of a breakpoint was supported.

RESULTS

Breathing modes

Our observations confirmed that *H. versicolor* tadpoles develop lungs and begin breathing within 3 days of hatching, at remarkably small body sizes (3.08 mm SVL). All *H. versicolor* tadpoles exhibited bubble-sucking breathing behavior from hatching to metamorphosis (Movies 1–3). We never observed the tadpoles breach the water’s surface in order to breathe. Large individuals did occasionally breach during explosive swimming bouts, but we never observed breathing during these events. We observed three different bubble-sucking modes distinguished by the number of suction events included within a single breathing bout: single bubble-sucking (SBS), double bubble-sucking (DBS) and triple bubble-sucking (TBS). DBS was most frequently observed, followed by SBS and then TBS (Table 1). TBS was only observed in two exceptionally large individuals that were raised separately from other tadpoles at very low density.

Air-breathing mechanics

SBS

SBS is initiated when a tadpole swims upward and attaches its oral disk to the underside of the water’s surface (Movie 1). When the mouth contacts the surface, the tadpole typically rocks from side to side with its mouth closed, pushing upward against the undersurface of the water. The tadpole then opens its mouth fully, forming the oral disk into a circular cup that is pressed to the surface for adhesion. Owing to the sub-terminal position of the mouth in *H. versicolor*, the tadpole often orients its body obliquely, ventral side up so that the mouthparts are aligned with the water’s surface (Fig. 1A). Immediately following attachment, buccal expansion draws the water’s surface layer into the mouth, forming an air bubble within the buccal cavity (Fig. 1B). After sucking in the bubble, the tadpole closes its mouth, severing the bubble’s connection to the air (‘pinch-off’) (Fig. 1C). Following pinch-off and a short pause, the tadpole elevates the buccal and pharyngeal floors, compressing the air bubble and forcing air into the lungs under positive pressure (Fig. 1D). Air remaining within the buccal cavity after the lungs fill is expelled when the tadpole opens its mouth and elevates the buccal floor, usually as the tadpole swims away from the surface (Fig. 1E). Fig. 2B is a schematic diagram of the kinematic events described above.

We were unable to observe lung emptying in small, SBS tadpoles. However, circumstantial evidence suggests that it occurs during the suction phase (see Discussion), as it does during DBS in larger tadpoles (see below).

DBS

DBS is distinguished from SBS by the addition of a second suction event immediately after the first (Movie 2). Following attachment, the tadpole begins suction I, during which a bubble is pulled down into the buccal cavity. The lungs empty into the buccal bubble while the mouth is connected to the surface air via a narrow stalk of air (Fig. 1G). Lung emptying is explosive, occurring in just a few milliseconds (Table 2, Fig. 2E). Immediately following lung emptying, the buccopharynx compresses and the buccal bubble, which until this point has remained attached to the surface by a stalk of air, returns to the surface, ending suction I. It is clear from the videos that no air enters the lungs during this terminal period of compression. A very brief interval follows in which the tadpole remains attached to the water’s surface by its mouthparts, but performs no breathing behaviors (Fig. 1H). A second suction event (suction II) is then initiated by a second buccopharyngeal

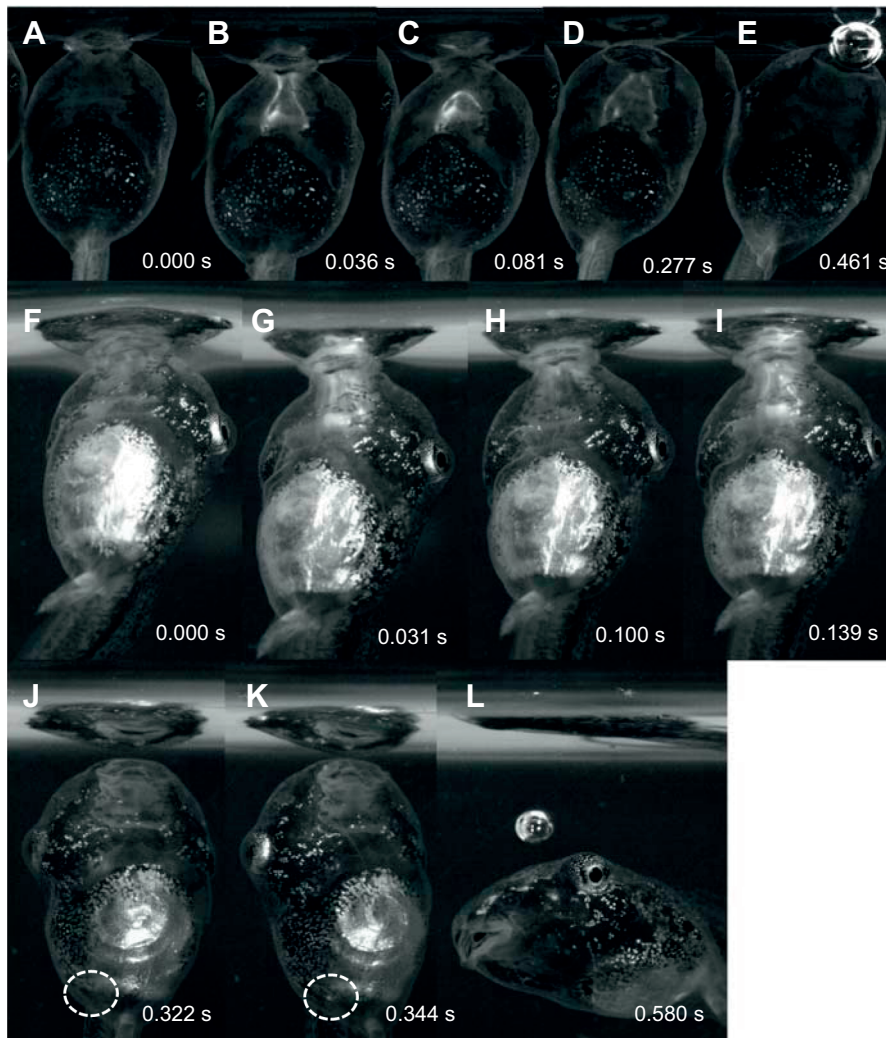

Fig. 1. Kinematic phases of single and double bubble-sucking in *Hyla versicolor*. Images are stills taken from Movies 1 and 2. (A–E) Single bubble-sucking (SBS): (A) attachment, (B) suction, (C) pinch-off, (D) compression and (E) release. (F–L) Double bubble-sucking (DBS): (F) attachment, (G) suction I, (H) interval, (I) suction II, (J) pinch-off and first part of compression, (K) second part of compression (dashed circle highlights the now inflated tip of the lung, which becomes visible at the tadpole's posterior end) and (L) release of excess air.

expansion. Suction II is similar to suction I, but without lung emptying (Fig. 1I). Suction II terminates with pinch-off of the buccal bubble, as in SBS, followed by compression, lung filling and expulsion of excess air (Fig. 1I–L). Fig. 2D is a schematic diagram of the kinematic events described above.

TBS

In TBS, the first two suction events are similar to suction I in DBS in that the mouth remains open with the buccal bubble attached and open to the surface. Following the second suction, the tadpole draws in a third buccal bubble, which is then pinched off and compressed, presumably forcing air into the lungs. Neither lung emptying nor lung filling was observed during TBS, but the large size and heavy pigmentation of the two individuals exhibiting this behavior probably obscured them.

Kinematic differences between SBS and DBS

The kinematic phases of SBS and DBS are qualitatively similar in form and, in most cases, similar in duration (Table 2; Figs S1, S2). Using a paired *t*-test, we found that DBS generally took longer than SBS [duration of SBS, 0.445 ± 0.135 s; duration of DBS, 0.518 ± 0.080 s; $P=0.0186$], but our covariance analysis suggested that this difference was not significant when body size was accounted for ($P_{\text{ANCOVA}}=0.159$). We found that DBS suction I was longer than SBS suction in both analyses [$SI_{\text{DBS}}=0.112 \pm 0.014$ s; $S_{\text{SBS}}=0.070 \pm 0.012$ s;

$P=2.63 \times 10^{-12}$; $P_{\text{ANCOVA}}=0.007$], while DBS suction II did not differ from SBS suction in either analysis [$SII_{\text{DBS}}=0.067 \pm 0.016$ s; $S_{\text{SBS}}=0.070 \pm 0.012$ s; $P=0.456$; $P_{\text{ANCOVA}}=0.696$].

Lung filling appeared to be significantly faster in DBS than in SBS from the *t*-test [$LF_{\text{DBS}}=0.027 \pm 0.020$ s; $LF_{\text{SBS}}=0.084 \pm 0.008$ s; $P=6.33 \times 10^{-7}$], but the data spanned too small a range of body sizes for the covariance analysis to assess significance when considering the effects of body size. Compression did not differ significantly between the two modes for either test [$C_{\text{DBS}}=0.333 \pm 0.076$ s; $C_{\text{SBS}}=0.374 \pm 0.121$ s; $P=0.136$; $P_{\text{ANCOVA}}=0.380$].

Ontogenetic shifts in breathing modes

Neither the total duration of SBS nor that of any of its kinematic phases changed significantly over ontogeny (Fig. S3: total duration versus SVL: $\beta=-0.012$, $P=0.408$; suction versus SVL: $\beta=0.00002$, $P=0.99$; compression versus SVL: $\beta=-0.012$, $P=0.338$; lung filling versus SVL: $\beta=0.0002$; $P=0.946$). However, the total duration of DBS and both suction phases increased significantly over ontogeny (Fig. S4). Total duration of DBS was positively correlated with body length ($\beta=0.014$, $P=0.037$), as were suction I ($\beta=0.0025$, $P=0.028$) and suction II ($\beta=0.0043$, $P=0.00037$) (Fig. S3). Lung emptying ($\beta=0.0004$, $P=0.467$), lung filling ($\beta=-0.0013$, $P=0.612$) and interval ($\beta=-0.0001$, $P=0.7757$) did not change significantly with body length.

The three observed breathing modes were not randomly distributed through the larval period (Fig. 3A). SBSs were

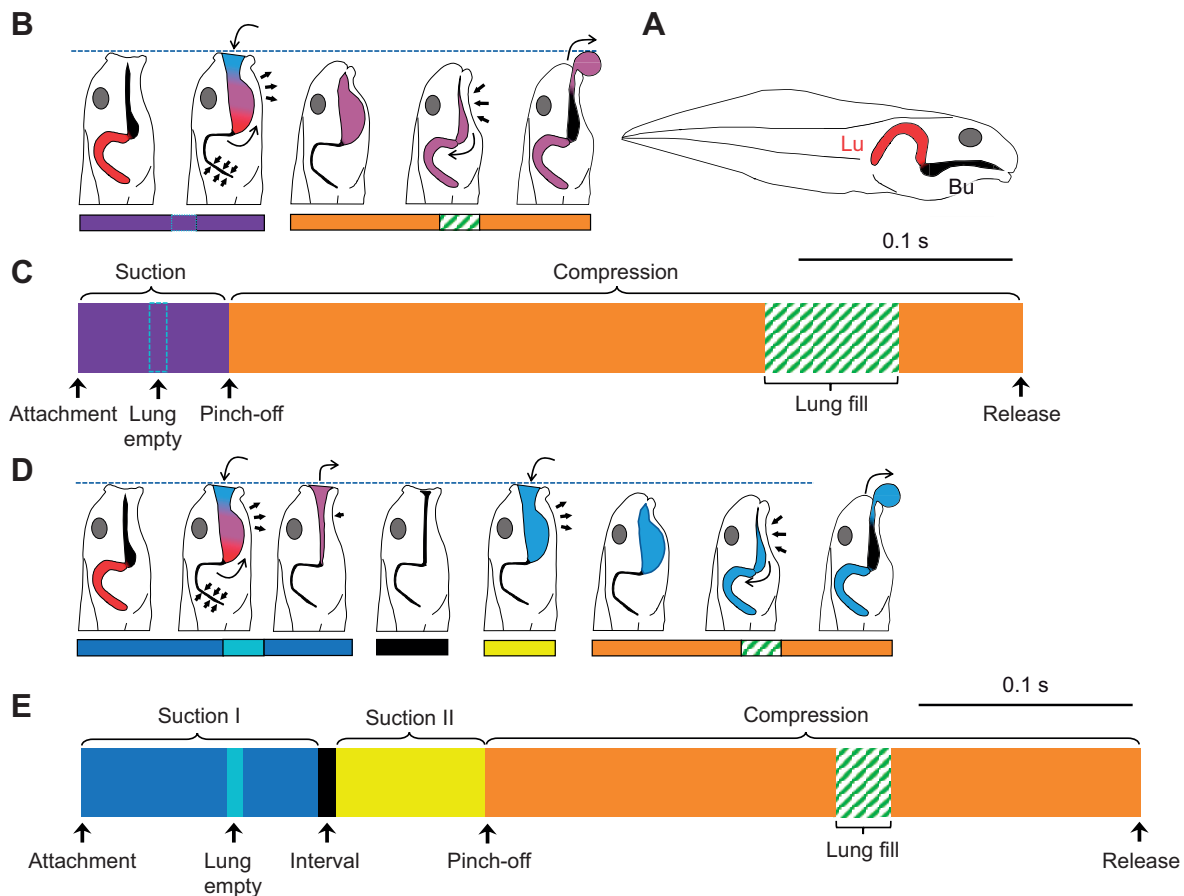

Fig. 2. Schematic diagram of air breathing in *H. versicolor*. (A) Between breathing bouts, tadpoles swim with lungs (Lu) full of deoxygenated air and the buccal cavity (Bu) empty or filled with water. (B) The kinematic phases of SBS. The colored bars below each schematic diagram correspond to those in C. (C) The length of each colored section represents the mean duration of each kinematic phase. The blue lines indicate approximately where we infer lung emptying occurs (see Results). (D) The kinematic phases of DBS. The colored bars below each schematic diagram correspond to those in E. (E) Timing of the kinematic events of DBS shown on the same scale as in C, with the lengths of each colored section corresponding to the mean duration of each kinematic phase. For A, B and D, deoxygenated air is colored red, oxygenated air is blue and mixed air is purple.

prevalent early in ontogeny, whereas DBSs came to dominate later. TBSs only occurred in two individuals very late in development. The relationship between SVL and breathing mode was highly significant ($P=2.65e-09$) with the transition from SBS to DBS occurring at 5.7 mm SVL (Fig. 3B).

Lung morphology

The number of pulmonary blood vessels increased from an average of 1 in the smallest individual examined (3 mm SVL) to over 11 in the largest (12 mm SVL) (Fig. 3C; Table S1). The breakpoint analysis identified 6.0 mm as the body size at which blood vessel number dramatically increased. The best fitting linear models for the two size classes had equal, positive slopes (Fig. 3C). The summed AIC scores of the split models was 59.55, compared with 65.69 for the single model, supporting the former. We conclude that at approximately 6 mm SVL, the lungs undergo a rapid maturation event during which they greatly increase their number of blood vessels (Fig. 4).

DISCUSSION

Key findings

At hatching, *H. versicolor* tadpoles perform gas exchange with external gills. We found that air breathing by means of bubble-sucking begins immediately after the external gills are covered with

skin and the tadpole begins to ventilate the gills via buccal pumping. This occurs early in development, at approximately 3 mm SVL, 3 days post-hatching. All air breathing is initially SBS, which persists until the tadpoles grow to be approximately 6 mm SVL. At that point, two major shifts occur: (1) DBS becomes the predominant breathing mode and (2) the number of blood vessels in the lungs abruptly increases from low to high. DBS continues until metamorphosis (Movie 3), at which point typical adult frog breathing commences.

Comparative mechanics of SBS and DBS

SBS and DBS are clearly very similar behaviors. They include nearly identical kinematic phases: attachment, suction, pinch-off and compression to fill the lungs. Most phases are similar in duration. Although we found that SI_{DBS} was significantly longer than S_{SBS} (Figs S1 and S2), the difference is likely an artifact of the methods we used to measure the duration of each phase. The end of SI_{DBS} includes a brief (30–40 ms) period of buccopharyngeal compression following suction when the buccal bubble returns to the surface. This period of compression is absent in S_{SBS} (and SI_{DBS}), when the bubble is pinched off rather than expelled. The difference was necessitated by the pragmatic need for a distinct kinematic event to mark the end of each phase. For S_{SBS} and SI_{DBS} , this was pinch-off; for SI_{DBS} , it was the moment the buccal bubble

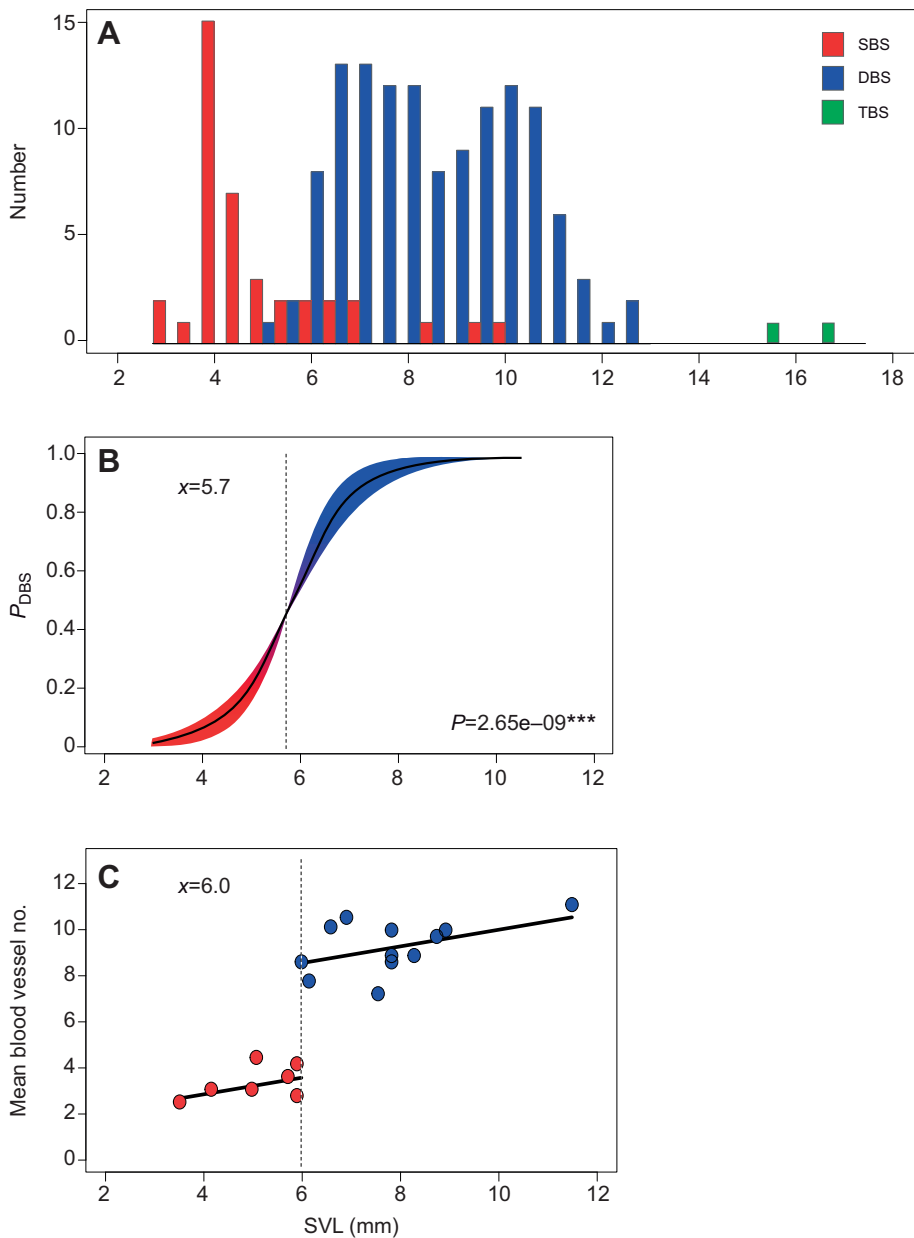

Fig. 3. Changes in breathing behavior and lung morphology over ontogeny. (A) Histogram showing the number of recorded instances of SBS, DBS and triple bubble-sucking (TBS). (B) The probability of performing a DBS through ontogeny. Confidence intervals are indicated by the red and blue shading. The dotted line indicates the snout-vent length (SVL) at which there is equal probability of performing a double suck or a single suck (5.7 mm). (C) Regressions of pulmonary blood vessel number versus body length using a split dataset (see Results). Red circles indicate hypothesized single bubble-sucks and blue circles indicate hypothesized double bubble-sucks. The dashed line indicates the transition from low to high lung vascularization, which was calculated to be 6.0 mm SVL.

had fully vacated the mouth. A comparison excluding this additional time would eliminate the apparent difference in duration of the two suction phases (Table 2).

LF_{DBS} was significantly shorter than LF_{SBS} (Fig. S1). Our sample did not allow us to determine whether this difference was related to size effects. It is possible that smaller, SBS tadpoles have less powerful oral compression pumps that take longer to fill the lungs, or that lung resistance is higher in smaller individuals.

We were not able to observe lung emptying directly during SBS in *H. versicolor*, as we could during DBS. Visualization is particularly difficult in small tadpoles (those performing SBS), because the lungs are very small and do not bulge externally, as they do when full in larger individuals. However, we believe that lung emptying often occurs during the suction phase of SBS because the lungs in tadpoles of other frog species, as well as in adult frogs, empty at a comparable phase of air breathing (Schwenk and Phillips, 2020; de Jongh and Gans, 1969; Gans et al., 1969; Gnanamuthu, 1936; Jones, 1982; Macintyre and Toews, 1976; Vitalis and

Shelton, 1990; West and Jones, 1974a,b). Alternatively, it has been suggested that tadpole lungs might empty passively via diffusion into surrounding tissues (Ultsch et al., 1999). In the latter case, the lungs are unlikely to empty completely, and air breathing at this stage might serve to refill the lungs. When we dissected unfixed, free-swimming tadpoles at small (SBS) sizes (< 5 mm SVL), we found the lungs to be at least partially inflated in all individuals. As such, when SBS tadpoles begin a breathing bout, there is likely to be some air in the lungs.

DBS differs from both SBS and breach breathing by the addition of a second suction event. The extra suction event separates lung emptying and lung filling, i.e. suction I empties the lungs and suction II draws in fresh air to fill the lungs. This may be functionally significant because it allows for the separation of incurrent and excurrent airflows during ventilation, which prevents mixing of depleted and fresh air (Fig. 2D). In contrast, during SBS, freshly inspired air mixes with either expired lung air during suction (Fig. 2B) or residual air in the lungs, as would also occur in breach

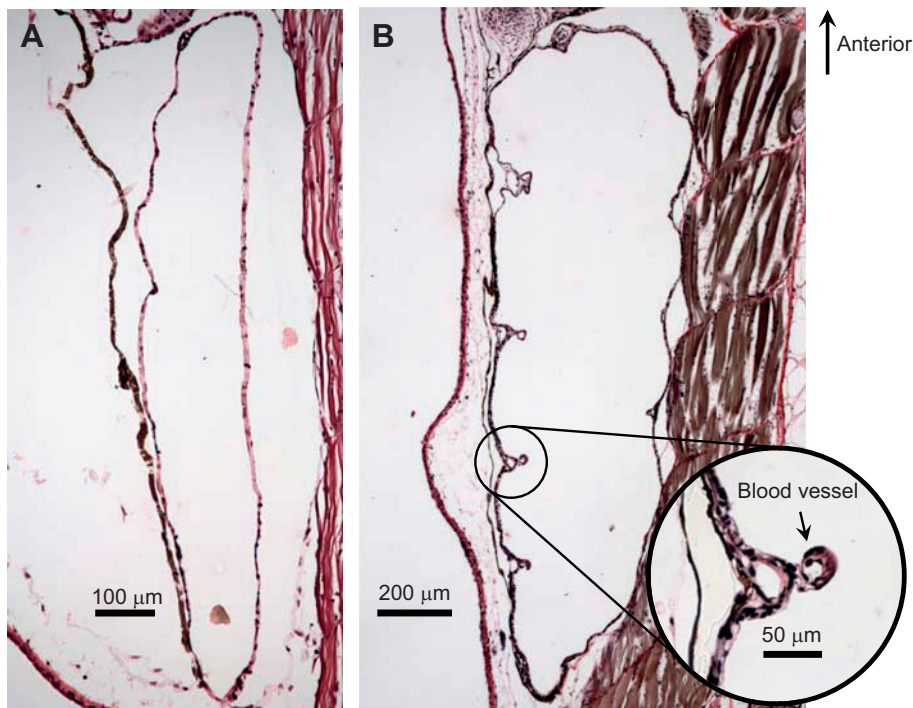

Fig. 4. Frontal sections through left lungs of *H. versicolor*. (A) A pre-transition tadpole (S-290, 5.9 mm SVL; Table S1). Note the lack of septae and vasculature. (B) A post-transition tadpole (S-283, 9.2 mm SVL; Table S1) showing incipient formation of septae with associated blood vessels.

breathing (Schwenk and Phillips, 2020). Because of these mechanical differences, we expect that DBS is functionally more efficient for gas exchange than SBS.

We speculate that the presence of TBS in two exceptionally large individuals may be related to their lung–buccal cavity volume ratio. If lung volume exceeded buccal volume, it would require more than one cycle to either empty or fill the lungs. The large aquatic salamander, *Amphiuma*, for example, requires multiple cycles to fill its lungs (Brainerd et al., 1993). However, during TBS, suction I and suction II occur with the mouth open, and the bubble open to the surface. The short compression that occurs at the end of each phase in concert with bubble evacuation therefore could not force air into the lungs. This can only occur during the compression phase with the mouth closed following suction III. Although unusual, it is possible that the extra suction event may be induced by the need to empty the lungs completely during suction I and suction II. Nevertheless, given the atypical laboratory rearing conditions and unusual size of these two individuals, it is likely that TBS is artifactual and not a naturally occurring behavior.

Ontogeny

All previously studied tadpoles undergo a transition from bubble-sucking to breach breathing over the course of their development prior to metamorphosis (Schwenk and Phillips, 2020). *Hyla versicolor* tadpoles, in contrast, never switch to breach breathing, but transition instead from SBS to DBS at approximately the same stage of development. The bubble-suck to breach transition is explained by the release from the physical constraint of surface tension (Schwenk and Phillips, 2020) but the shift from SBS to DBS in *H. versicolor* occurs at the seemingly arbitrary body length of 5.7 mm. This stage of development is also marked by a rapid shift in the degree of lung vascularization, suggesting that prior to this stage, the lungs are non-respiratory (Figs 3C and 4). Thus, SBS is probably not a major means of gas exchange in *H. versicolor* tadpoles. DBS,

however, is initiated at the point at which the lungs become well vascularized and, thus, likely represents a respiratory form of air breathing. This proposed difference in respiratory function between SBS and DBS aligns with our functional expectations given that SBS allows mixing of depleted and fresh air, whereas DBS ensures that the lungs are filled with only fresh air.

If SBS is non-respiratory, then why does it occur in *H. versicolor*? One possibility is that inflated lungs have functions other than respiration. Gee and Waldick (1995), for example, showed that *H. versicolor* tadpoles use inflated lungs to promote neutral buoyancy, which may help reduce the energetic cost of holding position in the water column. Alternatively, filling the lungs with air early in ontogeny might be necessary for proper lung development. Pronych and Wassersug (1994) found that when *Xenopus laevis* tadpoles were denied access to air after hatching, their ability to develop and inflate the lungs was delayed and the probability of successful metamorphosis significantly decreased (but see Rose and Jones, 2013). Buoyancy and developmental necessity are not mutually exclusive hypotheses, as both could provide selection pressure for recently hatched tadpoles to inflate their lungs prior to any role in gas exchange.

Evolution

The phenotypic similarity between SBS and DBS strongly suggests that one mode was derived from the other. While very preliminary, the phylogenetic distribution of SBS and DBS breathing behaviors strongly suggests that SBS is ancestral and DBS is a derived condition in anuran tadpoles (Fig. 5). This polarity is given some support by the character state distribution in another hylid species, *Pseudacris crucifer*. *Pseudacris crucifer* tadpoles transition from SBS to DBS like *H. versicolor*, but some individuals, at least, also perform breach breathing at low frequencies (Schwenk and Phillips, 2020). It may be that *P. crucifer* represents an evolutionarily intermediate condition, in which DBS has evolved, but breaching has not yet been eliminated.

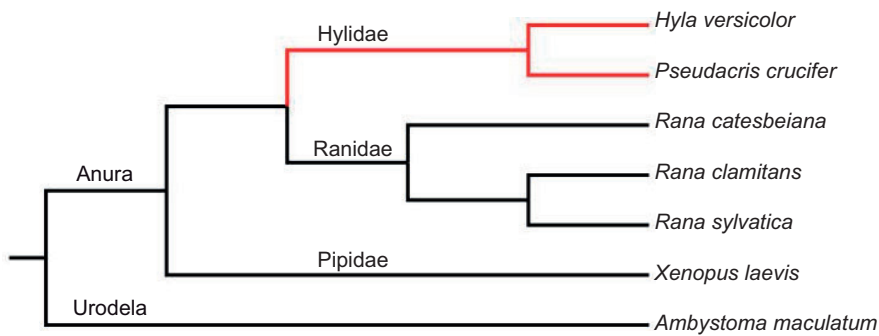

Fig. 5. Phylogenetic distribution of SBS and DBS in larval amphibians. The two hylid frogs (*Hyla versicolor* and *Pseudacris crucifer*) are the only taxa known to perform DBS (indicated in red); all other species so far examined exhibit only SBS (black). Evolutionary relationships from Pyron and Wiens (2013).

SBS could have been modified to produce DBS in two ways: either an additional suction phase was added *de novo* or the suction phase was extended and split in two. These two scenarios imply different hypotheses of homology between suction events in SBS and DBS, but the functional outcome is identical either way and the distinction is probably unresolvable.

Schwenk and Phillips (2020) suggested that organisms large and fast enough to break through the water's surface tension should breach to air breathe, yet *H. versicolor* continues bubble-sucking throughout the larval period and well into metamorphosis, despite growing physically capable of breaching the surface. We suggest that the failure to transition to breach breathing reflects specialization for bubble-sucking in *H. versicolor* (or hylids, more broadly) related to the evolution of DBS. The extra suction event during DBS potentially increases the efficiency of breathing, which breach breathing cannot do. The time above the surface during a breach breath is far too short to permit two suction events. Doing so would require a tadpole to swim actively, keeping its mouth above the water for enough time, which presumably would be energetically expensive and increase its exposure to visual predators. Owing to surface attachment before and during bubble-sucking, tadpoles appear to require little energy to remain in position while bubble-sucking, hardly using their tails while attached. As such, it is not surprising that bubble-sucking specialization is also manifested in the oral disk of *H. versicolor* tadpoles, which is markedly larger and possibly more fimbriated than in breach-breathing species (Fig. 6). These large mouthparts appear to make adhesion to the surface easier during bubble-sucking.

As noted, at least one other hylid tadpole, *P. crucifer*, employs DBS (Schwenk and Phillips, 2020). At this early stage of investigation, the phylogenetic extent of DBS within hylids is

unknown. However, based on the premise that efficient attachment is an important functional component of DBS, we believe that DBS and possibly other derived forms of bubble-sucking might be seen among tadpoles that specialize as neustonic surface feeders, as this behavior is often accompanied by enlarged mouthparts that aid in surface attachment during feeding (e.g. *Megophrys*, *Phasmahyla*, *Duellmanohyla*, *Leptodactylodon*, etc.: Inger, 1985; Mapouyat et al., 2014; Wells, 2007). We note in this regard that *H. versicolor* tadpoles are prodigious surface feeders as well (J.R.P. and K.S., unpublished observations).

Bubble-sucking in the context of vertebrate ventilation pumps

Previous investigations of air-breathing modes across vertebrates have revealed a biomechanical dichotomy distinguished by the number of buccopharyngeal expansion/contraction cycles they include (Brainerd et al., 1993; Brainerd, 1994). During 'two-stroke' breathing, which is characteristic of typical (anamniote) sarcopterygians, including lungfishes and adult frogs, the lungs empty as fresh air is inspired during a single buccopharyngeal expansion, and then some mix of fresh and previously inspired air is pumped into the lungs with a buccopharyngeal contraction (Fig. 7A). In tadpoles, both SBS and breach breathing are forms of two-stroke breathing, which is unsurprising, given that tadpoles are sarcopterygians (Fig. 7B). In contrast, typical air-breathing actinopterygian fishes use a 'four-stroke' pump to ventilate the lungs or swim bladders, which uses two expansion and two contraction cycles (Fig. 7C). During a four-stroke breath, the lungs are emptied into the buccopharynx and this air is fully expired prior to inspiration of fresh air into the mouth, separating the incurrent and excurrent air streams (Brainerd et al., 1993). In tadpoles, DBS is

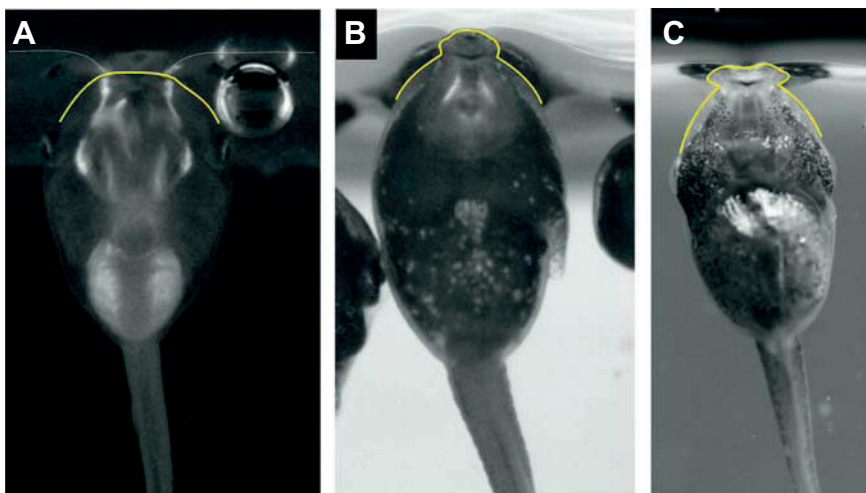

Fig. 6. Mouthparts of different tadpole species mid-bubble-suck. (A) An albino *Xenopus laevis* tadpole lacking an oral disk attaches to the surface of the water. (B) A *Rana clamitans* tadpole attaches with small, cup-like mouthparts. (C) A *Hyla versicolor* tadpole attaches with large, cup-like mouthparts during a DBS.

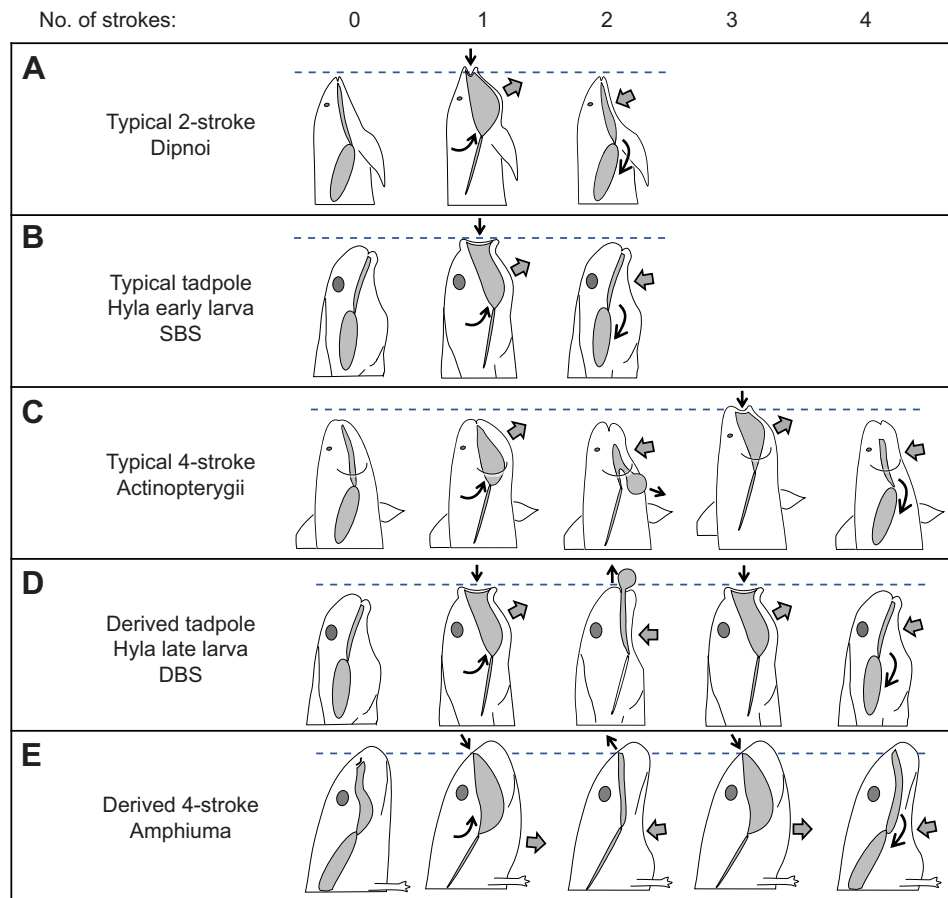

Fig. 7. Schematic diagram of two- and four-stroke breathing modes observed across vertebrates. (A) Two-stroke breathing in a lungfish (based on data in Bishop and Foxon, 1968). (B) Two-stroke breathing (SBS) in a hyloid tadpole (this study). (C) Four-stroke breathing in an actinopterygian (based on data in Brainerd et al., 1989). (D) Four-stroke breathing (DBS) in a hyloid tadpole (this study). (E) Four-stroke breathing in the aquatic salamander *Amphiuma* (modified from Simons et al., 2000). Thick, gray arrows indicate bucco-pharyngeal movements (expansion and contraction) and thin, black arrows indicate the direction of airflow into and out of the lungs and buccal chamber.

a form of four-stroke breathing, which is not typical of sarcopterygians (Fig. 7D).

While unusual, *H. versicolor* tadpoles are not the only sarcopterygians known to use a four-stroke air-breathing pump. It has also been described in the aquatic adults of several amphibians, including the salamanders *Amphiuma* (Fig. 7E) and *Cryptobranchus*, and the frogs *Pipa* and *Xenopus* (Martin and Hutchison, 1979; Brainerd et al., 1993; Brainerd and Dumka, 1995; Fonseca et al., 2012; Boutilier, 1984; Brett and Shelton, 1979; E. L. Brainerd, personal communication). *Hyla versicolor* is, however, the first species documented to make a transition from one pumping mode to the other over the course of larval ontogeny. Indeed, following the transition from SBS to DBS (two- to four-stroke pumping), *H. versicolor* then transitions again back to two-stroke breathing in its post-metamorphic adult form (J.R.P. and K.S., unpublished observations). *Hyla versicolor* is unlikely to be unique in this regard, however, as so few amphibian larvae have been examined in the context of lung ventilation pumps. Indeed, Schwenk and Phillips (2020) found that larval *X. laevis* perform typical, two-stroke, SBS air breathing, while Brett and Shelton (1979) found that adult *Xenopus* (atypically) employ four-stroke breathing. Many other species are likely to make similar larva–adult transitions in air-breathing modes.

The two-stroke, four-stroke dichotomy has historically been most useful in identifying evolutionary patterns of ventilatory mechanisms across vertebrates. However, our findings add to a growing body of

evidence suggesting substantial evolutionary diversity and, probably, lability in two- and four-stroke breathing mechanisms. Four-stroke breathing in various forms has arisen multiple times among sarcopterygians, but always in aquatic amphibians. Many of these putatively convergent breathing modes are, in fact, mechanically very different, with some including an initial intake of air to empty the lungs (e.g. *H. versicolor* tadpoles, adult *Amphiuma*; Fig. 7D,E) while others do not (e.g. adult *Xenopus*, actinopterygian fishes; Fig. 7C). Furthermore, it is often suggested that the advantage of four-stroke breathing is that it is more efficient than two-stroke because it reduces mixing of air streams. However, there are sarcopterygians with two-stroke breathing mechanisms that use alternative strategies to mitigate air mixing without additional strokes (e.g. Carrier and Wake, 1995; de Jongh and Gans, 1969; Minto et al., 2019). Ultimately, the most important characteristic of a breathing mode is its functional outcome, i.e. whether it prevents the mixing of incumbent and excurrent airstreams, and this can be achieved independent of the number of pharyngeal expansions and compressions during breathing. Classification according to buccopharyngeal stroke number may, in some cases, obscure mechanistic similarity and evolutionary relatedness. DBS in *H. versicolor* tadpoles, for example, is a four-stroke breathing mechanism, as is air breathing in actinopterygian fishes (Fig. 7C,D), yet DBS is clearly more similar mechanically and more related evolutionarily to SBS in other tadpoles, a two-stroke mechanism.

Acknowledgements

We thank Drs Elizabeth Jockusch and Mark Urban for their supportive, helpful discussions and comments on the manuscript. Dr Elizabeth Brainerd shared x-ray videos of salamander breathing, as well as her insights on vertebrate pumping mechanisms. Finally, we thank Andrew Stillman and Dr Paul Lewis for invaluable help with the statistical analysis, and several Schwenk lab undergraduates who contributed importantly to the project in a variety of ways: Andre Jang, Emilee Wooldrige, Gabrielle Fabian, Elle Parks and Jaimie Simmons.

Competing interests

The authors declare no competing or financial interests.

Author contributions

Conceptualization: J.R.P., K.S.; Methodology: J.R.P., K.S.; Formal analysis: J.R.P., A.E.H.; Investigation: J.R.P., K.S.; Resources: J.R.P., K.S.; Data curation: J.R.P.; Writing - original draft: J.R.P.; Writing - review & editing: J.R.P., A.E.H., K.S.; Visualization: J.R.P.; Supervision: K.S.; Project administration: K.S.; Funding acquisition: J.R.P., K.S.

Funding

We are grateful for financial support from the Department of Ecology and Evolutionary Biology, University of Connecticut to K.S. and an Ecology and Evolutionary Biology (EEB) Graduate Student Research Award to J.R.P.

Supplementary information

Supplementary information available online at <http://jeb.biologists.org/lookup/doi/10.1242/jeb.219311.supplemental>

References

- AVMA (2013). *AVMA Guidelines for the Euthanasia of Animals: 2013 edition*. Schaumburg, IL: American Veterinary Association.
- Bishop, I. R. and Foxon, G. E. H. (1968). The mechanism of breathing in the South American lungfish, *Lepidosiren paradoxa*; a radiological study. *J. Zool. Lond.* **154**, 263-271. doi:10.1111/j.1469-7998.1968.tb01663.x
- Boutillier, R. G. (1984). Characterization of the intermittent breathing pattern in *Xenopus laevis*. *J. Exp. Biol.* **110**, 291-309.
- Brainerd, E. L. (1994). The evolution of lung gill bi-modal breathing and the homology of vertebrate respiratory pumps. *Am. Zool.* **34**, 289-299. doi:10.1093/icb/34.2.289
- Brainerd, E. L. (2015). Major transformations in vertebrate breathing mechanisms. In *Great Transformations in Vertebrate Evolution* (ed. K. P. Dial, N. Shubin and E. L. Brainerd), pp. 47-62.
- Brainerd, E. L., Liem, K. F. and Samper, C. T. (1989). Air ventilation by recoil aspiration in polypterid fish. *Science* **246**, 1593-1595. doi:10.1126/science.246.4937.1593
- Brainerd, E. L. and Dumka, A. M. (1995). Mechanics of lung ventilation in an aquatic salamander, *Amphiuma tridactylum*. *Am. Zool.* **35**, 20A. doi:10.1093/icb/35.1.20
- Brainerd, E. L., Ditelberg, J. S. and Bramble, D. M. (1993). Lung ventilation in salamanders and the evolution of air-breathing mechanisms. *Biol. J. Linn. Soc.* **43**, 163-183. doi:10.1111/j.1095-8312.1993.tb00896.x
- Brett, S. S. and Shelton, G. (1979). Ventilatory mechanisms of the amphibian *Xenopus laevis*; the role of the buccal force pump. *J. exp. Biol.* **80**, 251-269.
- Brown, D. (2017). <https://physlets.org/tracker/>.
- de Jongh, H. J. and Gans, C. (1969). On the mechanism of respiration in the bullfrog *Rana catesbeiana*: a reassessment. *J. Morph.* **127**, 259-290. doi:10.1002/jmor.1051270302
- Carrier, D. R. and Wake, M. H. (1995). Mechanism of lung ventilation in the Caecilian *Dermophis mexicanus*. *J. Morph.* **226**, 289-295. doi:10.1002/jmor.1052260305
- Feder, M. E. (1984). Consequences of aerial respiration for amphibian larvae. In *Respiration and Metabolism of Embryonic Vertebrates* (ed. R. Seymour), pp. 71-86. Dordrecht: Junk. doi:10.1007/978-94-009-6536-2_5
- Feder, M. E. and Wassersug, R. J. (1984). Aerial versus aquatic oxygen consumption in larvae of the clawed frog, *Xenopus laevis*. *J. Exp. Biol.* **108**, 231-245.
- Fonseca, E. M., da Silva, G. S. F., Fernandes, M., Giusti, H., Noronha-de-Souza, C. R., Glass, M. L., Bicego, K. C. and Gargaglioni, L. H. (2012). The breathing pattern and the ventilatory response to aquatic and aerial hypoxia and hypercarbia in the frog *Pipa carvalhoi*. *Comp. Biochem. Physiol. A* **162**, 281-287. doi:10.1016/j.cbpa.2012.03.020
- Gans, C., de Jongh, H. J. and Farber, J. (1969). Bullfrog (*Rana catesbeiana*) ventilation: how does the frog breathe? *Science* **163**, 1223-1225. doi:10.1126/science.163.3872.1223
- Gee, J. H. and Waldick, R. C. (1995). Ontogenetic buoyancy changes and hydrostatic control in larval anurans. *Copeia* **4**, 861-870. doi:10.2307/1447034
- Gnanamuthu, C. P. (1936). The respiratory mechanism of the frog. *J. Exp. Zool.* **74**, 157-165. doi:10.1002/jez.1400740202
- Holmes, S. J. (1930). *The Biology of the Frog*. New York: The Macmillan Company.
- Inger, R. E. (1985). *Tadpoles of the Forested Regions of Borneo*. Chicago: Field Museum of Natural History. doi:10.5962/bhl.title.3403
- Jones, R. M. (1982). How toads breathe: control of air flow to and from the lungs by the nares in *Bufo marinus*. *Respir. Physiol.* **49**, 251-265. doi:10.1016/0034-5687(82)90077-9
- Liem, K. F. (1988). Form and function of lungs: the evolution of air breathing mechanisms. *Am. Zool.* **28**, 739-759. doi:10.1093/icb/28.2.739
- Macintyre, D. H. and Toews, D. P. (1976). The mechanics of lung ventilation and the effects of hypercapnia on respiration in *Bufo marinus*. *Can. J. Zool.* **54**, 1364-1374. doi:10.1139/z76-154
- Mapouyat, L., Hirschfeld, M., Rödel, M., Liedtke, H. C., Loader, S. P., Gonwou, N., Dahmen, M., Doherty-Bone, T. M. and Barej, M. F. (2014). The tadpoles of nine Cameroonian Leptodactylodon species (Amphibia, Anura, Arthroleptidae). *Zootaxa* **3765**, 29-53. doi:10.11646/zootaxa.3765.1.2
- Martin, K. M. and Hutchison, V. H. (1979). Ventilatory activity in *Amphiuma tridactylum* and *Siren lacertina* (Amphibia, Caudata). *J. Herpetol.* **13**, 427-434. doi:10.2307/1563477
- Minto, W. J., Giusti, H., Glass, M. L., Klein, W. and da Silva, G. S. F. (2019). Buccal jet streaming and dead space determination in the South American lungfish, *Lepidosiren paradoxa*. *Comp. Biochem. Physiol. A* **235**, 159-165. doi:10.1016/j.cbpa.2019.05.026
- Perry, S. F. and Sander, M. (2004). Reconstructing the evolution of the respiratory apparatus in tetrapods. *Respir. Physiol. Neurobiol.* **144**, 125-139. doi:10.1016/j.resp.2004.06.018
- Perry, S. F., Wilson, R. J. A., Straus, C., Harris, M. B. and Remmers, J. E. (2001). Which came first, the lung or the breath? *Comp. Biochem. Physiol. A* **129**, 37-47. doi:10.1016/S1095-6433(01)00304-X
- Presnell, J. K. and Schreiber, M. P. (1997). *Humason's Animal Tissue Techniques*, 5th edn. London: Johns Hopkins Press.
- Pronych, S. and Wassersug, R. (1994). Lung use and development in *Xenopus laevis*. *Can. J. Zool.* **72**, 738-743. doi:10.1139/z94-099
- Pyron, R. A. and Wiens, J. J. (2013). Large-scale phylogenetic analyses reveal the causes of high tropical amphibian diversity. *Proc. R. Soc. B* **280**, 20131622. doi:10.1098/rspb.2013.1622
- Rose, C. S. and Jones, B. (2013). Plasticity of lung development in the amphibian, *Xenopus laevis*. *Biology Open* **2**, 1324-1335. doi:10.1242/bio.20133772
- Rugh, R. (1951). *The Frog. Its Reproduction and Development*. Philadelphia: The Blakiston Company. doi:10.5962/bhl.title.6867
- Schwenk, K. and Phillips, J. R. (2020). Circumventing surface tension: tadpoles suck bubbles to breathe air. *Proc. R. Soc. B* **287**, 20192888. doi:10.1098/rspb.2019.2704
- Simons, R. S., Bennett, W. O. and Brainerd, E. L. (2000). Mechanics of lung ventilation in a post-metamorphic salamander, *Ambystoma tigrinum*. *J. Exp. Biol.* **203**, 1081-1092. doi:10.1098/rspb.2019.2704
- St. Mivart, G. (1880). *The Common Frog*. London: Macmillan and Co.
- Uitsch, G. R., Bradford, D. F. and Freda, J. (1999). Physiology. Coping with the environment. In *Tadpoles. The Biology of Anuran Larvae* (ed. R. W. McDiarmid and R. Altig), pp. 189-214. Chicago, US: University of Chicago Press.
- Vitalis, T. Z. and Shelton, G. (1990). Breathing in *Rana pipiens*: the mechanism of ventilation. *J. Exp. Biol.* **154**, 537-556.
- Wassersug, R. J. and Seibert, E. A. (1975). Behavioral responses of amphibian larvae to variation in dissolved oxygen. *Copeia* **1**, 86-103. doi:10.2307/1442410
- Wassersug, R. J. and Yamashita, M. (2000). The mechanics of air-breathing in anuran larvae: implications to the development of amphibians in microgravity. *Adv. Space Res.* **25**, 2007-2013. doi:10.1016/S0273-1177(99)01006-6
- Weisz, P. B. (1945). The development and biology of the larva of the South African clawed toad, *Xenopus laevis*. II. The hatching and the first- and second-form tadpoles. *J. Morph.* **77**, 119-283. doi:10.1002/jmor.1050770202
- Wells, K. D. (2007). *The Ecology and Behavior of Amphibians*. Chicago: The University of Chicago Press. doi:10.7208/chicago/9780226893334.001.0001
- West, N. H. and Burggren, W. W. (1982). Gill and lung ventilatory responses to steady-state aquatic hypoxia and hyperoxia in the bullfrog tadpole. *Resp. Phys.* **47**, 165-176. doi:10.1016/0034-5687(82)90109-8
- West, N. H. and Jones, D. R. (1975a). Breathing movements in the frog *Rana pipiens*. I. The mechanical events associated with lung and buccal ventilation. *Can. J. Zool.* **53**, 332-344. doi:10.1139/z75-042
- West, N. H. and Jones, D. R. (1975b). Breathing movements in the frog *Rana pipiens*. II. The power output and efficiency of breathing. *Can. J. Zool.* **53**, 345-353. doi:10.1139/z75-043
- Zeileis, A., Leisch, F., Hornik, K. and Kleiber, C. (2002). strucchange: An R package for testing for structural change in linear regression models. *J. Stat. Softw.* **7**, 1-38. doi:10.18637/jss.v007.i02
- Zeileis, A., Kleiber, C., Kraemer, W. and Hornik, K. (2003). Testing and dating of structural changes in practice. *Comp. Stat. Data Anal.* **44**, 109-123. doi:10.1016/S0167-9473(03)00030-6