

## Time-domain signal divergence and discrimination without receptor modification in sympatric morphs of electric fishes

Matthew E. Arnegard\*, B. Scott Jackson and Carl D. Hopkins

Department of Neurobiology and Behavior, Cornell University, Ithaca, NY 14853, USA

\*Author for correspondence (e-mail: mea21@cornell.edu)

Accepted 22 March 2006

### Summary

Polymorphism in an animal communication channel provides a framework for studying proximate rules of signal design as well as ultimate mechanisms of signal diversification. Reproductively isolated mormyrid fishes from Gabon's *Brienomyrus* species flock emit distinctive electric organ discharges (EODs) thought to function in species and sex recognition. Species boundaries and EODs appear congruent in these fishes, with the notable exception of three morphs designated types I, II and III. Within the species flock, these morphs compose a monophyletic group that has recently been called the *magnostipes* complex. Co-occurring morphs of this complex express distinctive EODs, yet they appear genetically indistinguishable at several nuclear loci. In this study, we investigated EOD discrimination by these morphs using both behavioral and physiological experiments. During the breeding season, wild-caught type I and type II males showed evidence that they can discriminate their own morph's EOD waveform from that of a sympatric and genetically distinct reference species. However, we found that type I and type II males exhibited an asymmetry in unconditioned responses to paired playback of EODs recorded from type I *versus* type II females. Males of the type II morph responded preferentially to EODs of type II females, whereas type I males did not appear to discriminate homotypic and

heterotypic EODs in our experimental paradigm. Part of this behavioral asymmetry may have resulted from a previously undetected difference in adult size, which may have enhanced apparent discrimination by the smaller morph (type II) due to a relatively higher risk of injury from the larger morph (type I). Knollenorgan receptors, which mediate electrical communication in mormyrids, showed similar spectral tuning in type I and type II. These electroreceptors coded temporal features of any single *magnostipes*-complex EOD with similar patterns of time-locked spikes in both morphs. By contrast, Knollenorgans exhibited distinctive responses to different EOD waveforms. These results suggest that discrete EOD variation in this rapidly diversifying complex is functional in terms of morph-specific advertisement and recognition. Time-domain signal divergence has outpaced frequency-domain divergence between sympatric morphs, requiring little to no change in receptor response properties. We discuss our findings in light of a model for EOD time-coding by the Knollenorgan pathway, as well as evolutionary hypotheses concerning sympatric signal diversification in the *magnostipes* complex.

Key words: Mormyridae, playback experiment, Knollenorgan receptor, tuning curve, temporal coding, signal design, multiple EOD dimorphisms.

### Introduction

Variation in courtship signals among closely related species can arise when signals display a potential mate's genetic lineage, quality and/or offspring mating potential. While receptor tuning is often optimized for the detection of such signals (Gerhardt and Huber, 2002), the sensory side of these signaling systems also involves mate recognition and preference. For example, intersexual selection by mate choice can play an important role in driving signal divergence and speciation among populations (Masta and Maddison, 2002; Allender et al., 2003). It has also been proposed that pre-existing biases in preferences are involved

in the origin of signals within some lineages (Ryan, 1990; Endler and Basolo, 1998; Wilczynski et al., 2001). A widespread yet currently underappreciated cause of interspecific diversification in sexually isolating signals and mating preferences involves species recognition in conjunction with deleterious fitness consequences of heterotypic or hybrid matings (Servedio and Noor, 2003). Regardless of the combination of influences that affects signal divergence, important interactions between the production and reception sides of communication are expected during the evolution of signaling systems.

A recently discovered species flock of African mormyrid

fishes (Sullivan et al., 2002) is well suited for studying signal diversification because its constituent species exhibit interspecific variation in a relatively simple component of an electrical communication system. All mormyrid fishes generate brief, pulse-like electric organ discharges (EODs) by means of an electric organ in their caudal peduncle (Bennett, 1971a). Different classes of electroreceptors underlie active electrolocation and communication by detecting the distortions in self-generated electric fields or the EODs of other individuals, respectively (Hopkins, 1986; Kramer, 1990; Moller, 1995; von der Emde, 1999). Within individuals, the sequence of pulse intervals (SPI) between successive EODs varies rapidly in different electrolocating or social contexts (e.g. Arnegard and Carlson, 2005). By contrast, the comparatively fixed waveform of each EOD pulse is shaped by much slower modifications in the anatomy and physiology of the electric organ (Bass and Hopkins, 1983; Bass, 1986; Caputi et al., 2005). Despite EOD elongation in breeding males, mormyrids living in species-rich assemblages are characterized by rather stereotyped, species-typical EODs that are amenable to quantitative comparison (Hopkins, 1999; Arnegard and Hopkins, 2003; Lavoué et al., 2004; Feulner et al., 2006). The largest known radiation of EODs among closely related species occurs in a riverine species flock from Gabon (Central Africa), members of which have been assigned to the genus *Brienomyrus* (Sullivan et al., 2002). Sympatric populations of *Brienomyrus* that differ in appearance and EOD waveform are reproductively isolated from one another (Arnegard et al., 2005). Extensive interspecific signal diversification motivates the hypothesis that EOD discrimination contributes to species recognition in this group of fishes. Several behavioral studies have provided strong evidence that mormyrids can recognize species, sex and/or individuals based on EOD variation (Hopkins and Bass, 1981; Graff and Kramer, 1992; Paintner and Kramer, 2003; Hanika and Kramer, 2005).

Among the different kinds of electroreceptors possessed by mormyrids, Knollenorgans are responsible for communication (Bennett, 1965; Moller and Szabo, 1981; Hopkins, 1986; Bell and Grant, 1989; Paintner and Kramer, 2003). The Knollenorgan pathway is briefly inhibited each time a fish fires its own electric organ, resulting in a selective responsiveness to EODs produced by other individuals rather than to self-generated EODs (Zipser and Bennett, 1976; Mugnaini and Maler, 1987; Bell and Grant, 1989). Knollenorgan cells fire spike-like receptor potentials that are time locked to outside negative-to-positive (N→P) voltage transients (Bennett, 1971b; Szabo and Fessard, 1974). When receptors are activated in nature by an EOD from another fish, Knollenorgans on opposite sides of an individual's body respond to different phases of the stimulus. N→P transients in one polarity of an EOD waveform experienced on one side of the body become P→N transients in the opposite polarity waveform experienced on the other side of the body. The result is fixed latencies between Knollenorgan spiking on

opposite sides of the receiver's body in response to a single EOD. In this way, mormyrids are thought to distinguish EOD features, such as overall duration, by comparing spike latencies arising from opposing body regions (Hopkins and Bass, 1981). Such a comparison apparently takes place within the midbrain torus semicircularis (Xu-Friedman and Hopkins, 1999).

#### *An emerging model system for studying sympatric signal diversification*

Our study focuses on the *magnostipes* complex (Sullivan et al., 2004), which is nested within Gabon's *Brienomyrus* species flock and contains three morphs called types I, II and III (Arnegard et al., 2005). Similarly sized individuals of co-occurring morphs cannot be distinguished on the basis of external appearance. Rather, the morphs are defined by their characteristic EOD waveforms (Fig. 1). One or two morphs can be found at each of several sites throughout Gabon (Fig. 2). Collections made from the Ivindo River between the middle of September and early December (i.e. at the beginning of a long, bimodal rainy season) have revealed that mature type I and type II males are more likely to display elongated EODs during this period of breeding activity (Fig. 1). At other sites, males and females of a type III morph have also been collected, although sampling has been insufficient to ascertain the degree of seasonal waveform elongation by type III males. Wherever the morphs co-occur, one is always type I; the other can be either type II or type III (Fig. 2). Measurable differences in power spectra exist among EODs of the *magnostipes* complex (Table 1), yet it is the time-domain waveform that differs most obviously between sympatric morphs (Fig. 1). For example, the first of two major waveform peaks is head-positive in the EOD of type II. Head-positivity corresponds to current inside the animal flowing in the direction of the head (i.e. an electrode in the environment near the head is positive relative to an electrode near the tail). In the case of type I, the first major peak in the EOD is head-negative. In contrast to other sympatric mormyrids exhibiting distinctive EODs, reproductive isolation has not been genetically demonstrated between *magnostipes*-complex morphs. No robust differences at five microsatellite loci occur between sympatric morphs despite their strikingly different EODs. Nevertheless, allopatric populations of these morphs exhibit signs of strong genetic isolation from one another (Arnegard et al., 2005).

The *magnostipes* complex is a particularly promising system with which to study sympatric signal divergence due to the genetic similarity of co-occurring morphs and the natural replication that exists in the form of multiple dimorphic populations. Knowledge of whether these morphs respond to differences in the EODs they produce is critical to understanding the origins and significance of polymorphism in their electric signals. Here, we report on two sets of experiments in which we tested whether EODs can potentially mediate morph recognition: (1) paired playbacks of female EODs to breeding males; and (2) electrophysiological

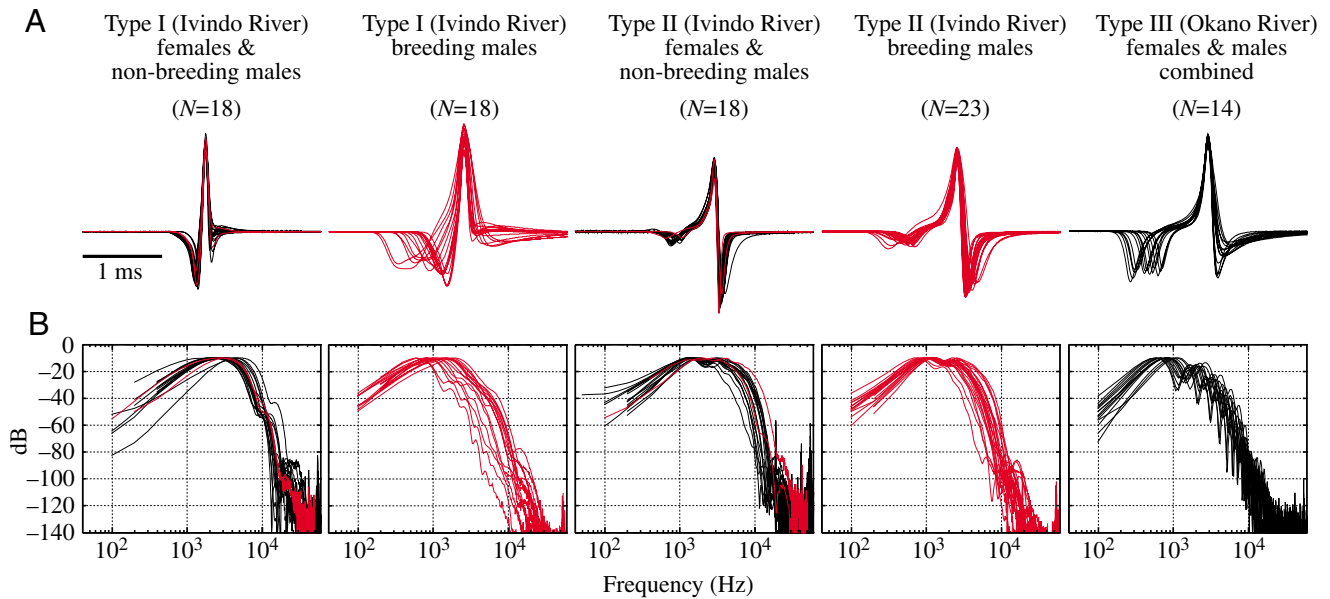

Fig. 1. Examples of electric pulses produced by three morphs of the *magnostipes* complex. (A) Time-domain EOD waveforms of multiple individuals. All voltage traces are standardized to the same peak-to-peak amplitude, plotted as overlays of waveforms recorded from  $N$  unique individuals and aligned by their head-positive peaks (with head-positivity up). Type III waveforms (all from a site near the village Na) were recorded in previous studies (Sullivan et al., 2004; Arnegard et al., 2005). (B) Power spectra calculated for the same EODs. Red voltage traces and power spectra correspond to DC recordings (bandwidth 0–50 kHz). All other recordings in black were AC-coupled (bandwidth 0.1 Hz–50 kHz). AC-coupling did not detectably alter type I and type II female-like EODs relative to DC recordings. Some measurements of EOD power spectra (also extremely similar between morphs) were previously provided for Ivindo River type I and type II females and non-breeding males by Hopkins, who referred to them as *Hippopotamyrus batesii* ‘reverse polarity’ and *H. batesii* ‘triphasic’, respectively (Hopkins, 1981). Note also that Hopkins shows a breeding male EOD of the type I morph in the right column of his fig. 2 (Hopkins, 1981).

characterization of Knollenorgan responses to different EOD waveforms.

### Materials and methods

#### *Field playback experiments during the breeding season*

In 2002, we collected adult specimens of the *magnostipes* complex in the Makokou region of the Ivindo River from September to November, a period when heavy rain causes floodplain inundation and triggers breeding in many mormyrid species (Fig. 2, inset). Individuals were obtained from the main channel of the Ivindo River (up to ~500 m wide) and several small tributaries (<10 m wide) within 4 km of the Institut de Recherche en Écologie Tropicale (I.R.E.T.; Fig. 2). Collections in the main channel were made at night with worm-baited fish traps or cast nets. Collections in the tributary streams were made during the day by localizing individuals with an electrode and oscilloscope and chasing them into handheld hoop nets. Locations of collection sites are shown in the regional map of Fig. 2.

We recorded EODs from each specimen in a small aquarium filled with water from the collection locality (conductivity, 12–28  $\mu\text{S cm}^{-1}$ ; temperature, 21–24°C; pH, 4.5–5.5). Recordings were made as the individual faced the positive pole of an Ag/AgCl electrode, with the negative pole positioned posterior to the animal’s tail. EODs were amplified using a

low-noise, BMA-831/XR differential bioamplifier (CWE Inc., Ardmore, PA, USA) and viewed on a Tektronix 222 digital oscilloscope (Tektronix Inc., Beaverton, OR, USA) to ensure they were not overloaded or otherwise distorted. EODs were then digitized with a Wavebook (16-bit, 200 kHz; Iotech Inc., Cleveland, OH, USA) and stored on a portable computer using custom software. As in previous studies (Arnegard and Hopkins, 2003; Arnegard et al., 2005), EOD recordings were either DC- (amplifier bandwidth, 0–50 kHz) or AC-coupled (bandwidth, 0.1 Hz–50 kHz). Power spectra of EODs were estimated using the power spectral density function in Matlab v.6.5.1 (The MathWorks, Inc., Natick, MA, USA). Immediately after completing both recordings and playbacks for a given individual (see below), we euthanized it by administering an overdose of the anesthetic MS222. We measured the individual’s standard length (SL) to the nearest 0.5 mm (Boden et al., 1997) and determined its sex and breeding condition by direct gonadal examination. Specimens were fixed in 10% formalin for two weeks, transferred to 70% ethanol and deposited in the Cornell University Museum of Vertebrates (cat. nos. CU89037, 89351–2, 89356–8, 89363–6, 89370, 89373 and 89382–3).

During our collections, we found breeding males and gravid females of each Ivindo River morph (types I and II). A subset of captured males exhibited three androgen-dependent character states indicative of breeding condition: (1) a notched

anal fin base (Herfeld and Moller, 1998); (2) an elongated EOD waveform (Bass and Hopkins, 1985); and (3) an enlarged testis. Many females also proved to be gravid with ripe eggs, the condition of which was based on limited experience breeding *magnostipes*-complex morphs in the laboratory (M.E.A., unpublished). Compared with the vigorous responses that unconditioned males exhibited to playback of a wide range of EODs during preliminary trials (e.g. see Results), unconditioned females appeared relatively unresponsive to electrical playbacks. Therefore, we focused our experiments on naive male subjects exhibiting both externally verifiable character states indicative of breeding activity. An enlarged testis was also subsequently confirmed in each subject after it was euthanized.

Two-channel playbacks were conducted at I.R.E.T. using clear acrylic chambers like the one shown in Fig. 3. These aquariums were filled with water from the collection locality and provisioned with a central PVC tube shelter. Solitary males

were used in experiments soon after capture (i.e. after 24–36 h of acclimation to their chambers). Each male was then simultaneously presented with two digitally synthesized signals consisting of independently controlled EOD waveforms and SPI rhythms (16-bit and down-sampled to 96 kHz). Each signal was played through a different bipolar electrode (Ag/AgCl) situated at each end of the aquarium (Fig. 3). We used an Edirol UA-5 digital playback device (D/A in Fig. 3; Roland Corp., Bellingham, WA, USA) and Cool Edit 2000 software (Syntrillium, Phoenix, AZ, USA) to perform these playbacks. Positive and negative poles of each electrode (oriented parallel to the long axis of the playback aquarium) were separated by 36 mm. Signals from the UA-5 device were amplified using a standard, dual audio power amplifier (LM1877N-9; National Semiconductor, Santa Clara, CA, USA). The output of each channel was isolated using a JT-6110K-B transformer (ISO in Fig. 3; Jensen Transformers, Inc., Van Nuys, CA, USA), which provided an additional 8:1

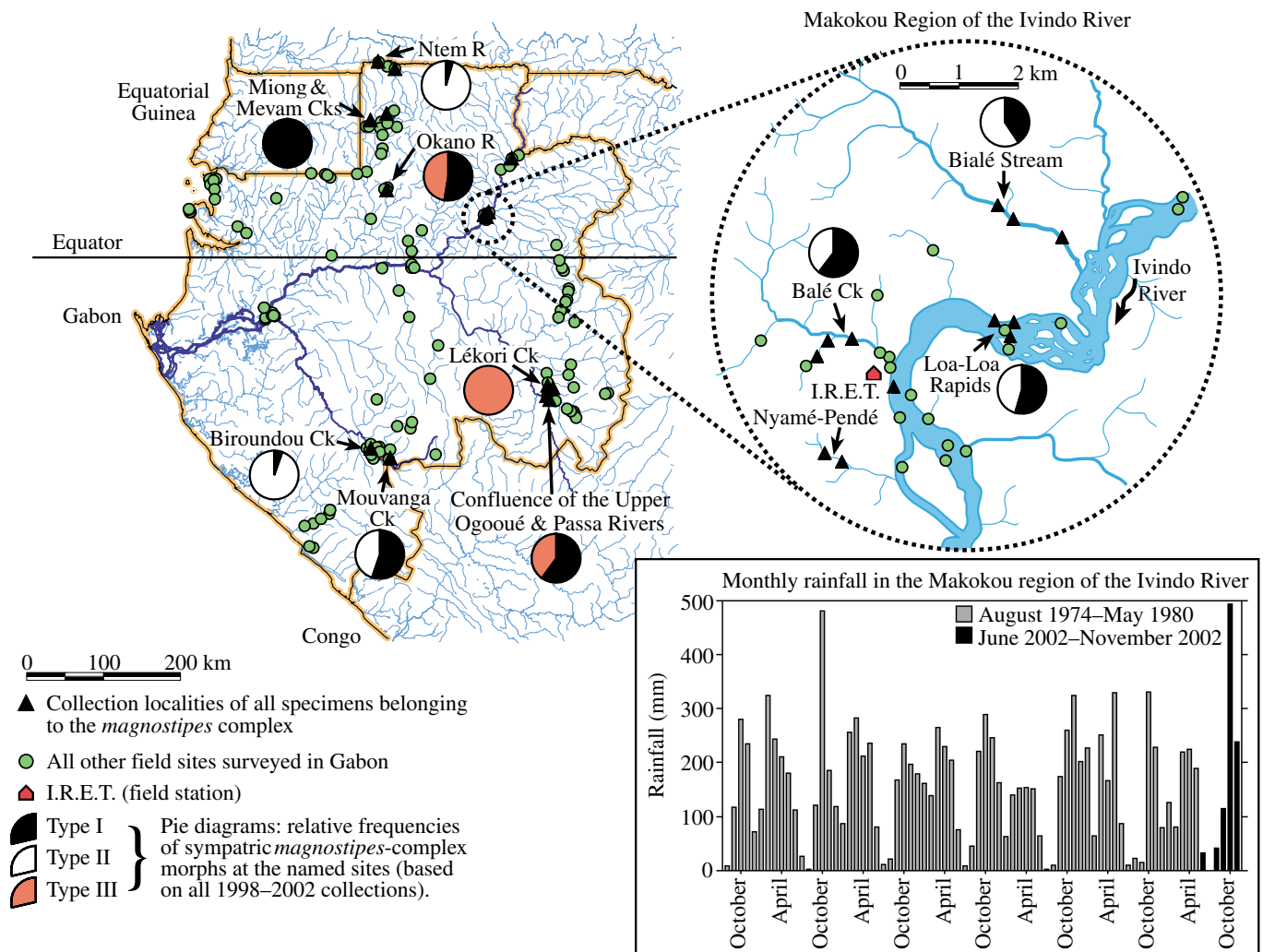

Fig. 2. Drainage map of Gabon showing the known distribution of the *magnostipes* complex (black triangles) based on all 1998–2002 collections. Pie diagrams show relative abundances of sympatric morphs at select sites. Rectangular inset: monthly precipitation over several years in the Makokou region (gray bars; data collected by C.D.H.) concatenated with data for the 2002 playback experiments (black bars; data collected by Direction de Météorologie, Makokou).



Table 1. Multiple comparisons of peak-amplitude frequencies (from power spectra) among the five groups of EODs shown in Fig. 1

Group	N	Mean peak-amplitude frequency (Hz)	P-value of Fisher LSD multiple comparison test			
			vs type I females and non-breeding males	vs type I breeding males	vs type II females and non-breeding males	vs type II breeding males
Type I females and non-breeding males	18	2973 ( $\pm$ 184)				
Type I breeding males	18	1088 ( $\pm$ 93)	<b><i>P</i>&lt;0.0001</b>			
Type II females and non-breeding males	18	1771 ( $\pm$ 151)	<b><i>P</i>&lt;0.0001</b>	<b><i>P</i>=0.0001</b>		
Type II breeding males	23	1138 ( $\pm$ 64)	<b><i>P</i>&lt;0.0001</b>	<i>P</i> =0.7569	<b><i>P</i>=0.0002</b>	
Type III females and males combined	14	802 ( $\pm$ 49)	<b><i>P</i>&lt;0.0001</b>	<i>P</i> =0.1209	<b><i>P</i>&lt;0.0001</b>	<i>P</i> =0.0563

EODs were recorded at the Ivindo River from adults of the type I and type II morphs or at the Okano River from all sub-adults and adults of type III ( $N$ =number of individuals compared). For each group, the table gives the mean peak-amplitude frequency ( $\pm$ s.e.m.). These means differ significantly among groups ( $F_{4,86}=50.48$ ;  $P<0.0001$ ; one-way ANOVA). The table also provides  $P$ -values for *post-hoc* comparisons of means between all possible pairs of groups (based on the Fisher LSD test, which is relatively liberal in terms of finding significant differences).

step-up in voltage. The specified frequency response of the UA-5 device (flat to within  $-2$  dB from 20 Hz–40 kHz) limited the bandwidth of our playback system, which resulted in no detectable distortion of playback EODs.

To calibrate our system to natural signal amplitudes, we confined an adult *magnostipes*-complex female in the tube shelter with fine netting secured over either end, and we recorded the peak-to-peak amplitude of her EOD from a

bipolar electrode at 20 cm distance. Next, one of the playback electrodes was identically enclosed in the tube. A previously recorded copy of the female's EOD was played from either channel of the UA-5 device through this electrode, and its amplitude was measured at the same distance and adjusted to approximate that of the live female's EOD. With playback electrodes positioned as in all trials, the measured peak-to-peak field strength generated by either calibrated channel was  $1.2 \text{ mV cm}^{-1}$  at the position of the central shelter (water conductivity  $27.5 \text{ }\mu\text{S cm}^{-1}$  for this measurement; central shelter removed; positive and negative poles of the recording electrode 10 cm apart, rotated parallel to the aquarium's long axis to give the highest recording amplitude, their bipole midpoint centered over the shelter's usual position at a distance of 35 cm from the midpoint of the playback electrode). Open-circuit source potential of the calibrated test EOD was  $19.6 \text{ V}$  peak-to-peak, which is slightly less than that measured for an unloaded electric organ in somewhat larger individuals of the mormyrid species *Gnathonemus petersii* (Bell et al., 1976). Subsequent to our calibration, the amplitude of one source EOD was slightly decreased using a custom Matlab routine applied to each pair of playback signals, such that the sum of squared voltages of each EOD was the same (after resampling to 96 kHz). This ensured that paired EODs had the same energy content.

During each playback trial, a male was simultaneously presented with two EOD waveforms randomly selected from a library of signals recorded in the Makokou region. In some trials, a homotypic female EOD was presented together with a heterotypic female EOD (e.g. homotypic and heterotypic EODs played to a type I male were of types I and II, respectively). In other trials, a homotypic female EOD was presented with a heterospecific female EOD recorded from the undescribed sympatric species that has been called the

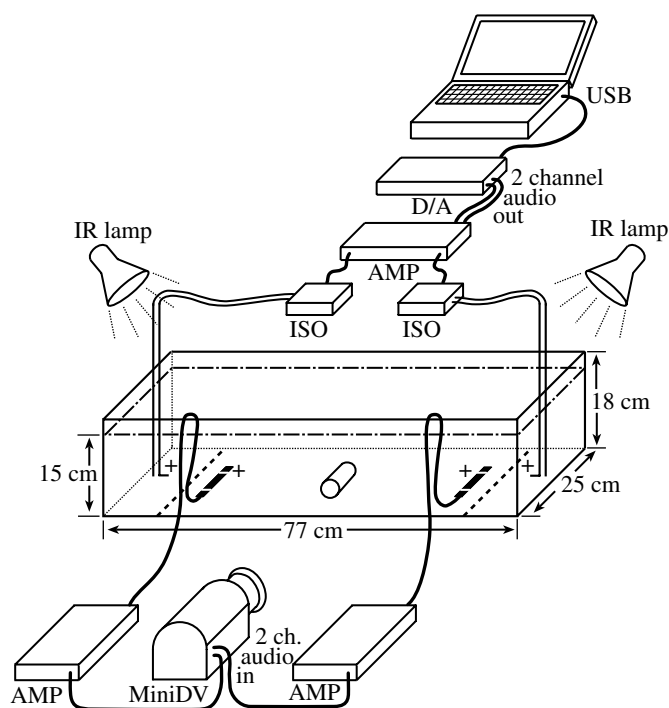
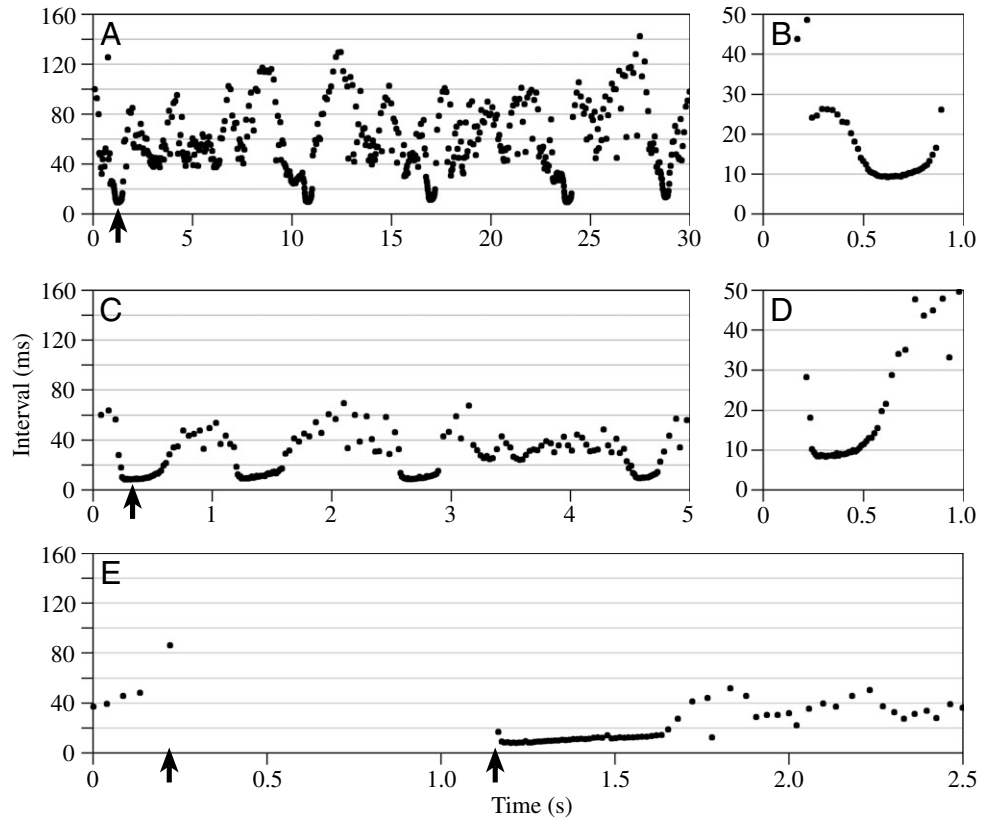

Fig. 3. Schematic diagram of the experimental playback system.

Fig. 4. Sequences of pulse intervals (SPIs) used for playbacks (A,B) and recorded from males in response to playbacks (C–E). All SPIs are plotted as time intervals between adjacent EODs *versus* temporal positions of the intervals in sequence. (A) Playback SPI recorded from an apparent female of the type I morph (specimen 2319; cat. no. MRAC 77-41-P-45; collected just below Loa-Loa Rapids; SL=82 mm). The first smooth acceleration in this SPI (arrow) is expanded in B. (C) Examples of bursts of EODs that males only produced within 10 cm of either playback electrode. One burst indicated by an arrow is expanded in D. (E) In many cases, males exhibited discharge cessation while rapidly approaching a playback electrode. Both approach and cessation occurred between the arrows in E. Cessations were usually followed by one or more bursts when the male neared the electrode.



following names: *Brienomyrus* sp. 'CAB' (Sullivan et al., 2002; Arnegard and Hopkins, 2003; Sullivan et al., 2004; Arnegard et al., 2005), *Brienomyrus* sp. 3 (Alves-Gomes and Hopkins, 1997; Hopkins, 1999) and *Brienomyrus brachyistius* 'long biphasic' (*l. bp.*) (Hopkins, 1981; Bass and Hopkins, 1983; Hopkins, 1986). We adopt the most recent nomenclature for this 'reference' species and hereafter abbreviate its name as 'CAB'.

Each of the paired EODs was presented using the same 30-s SPI (Fig. 4A,B), which was recorded from a type I individual (SL=82 mm) exhibiting a straight anal fin base and female-like EOD. The playback SPI, which was recorded from this individual at the I.R.E.T. field station during the day on 28 October (1976) while it was isolated in a small aquarium, has a total of 625 inter-pulse intervals (mean interval  $\pm$  s.d.,  $48 \pm 30$  ms). The SPI contains five 'smooth accelerations' (Bell et al., 1974; Hopkins, 1986; Carlson, 2002). No detailed studies of the patterns and contexts of SPI production have been made for the *magnostipes* complex (cf. Carlson and Hopkins, 2004). Therefore, no information is available concerning the stereotypy of smooth accelerations in this complex, nor is anything known about their signaling function, if any, when produced by a socially isolated individual. Nevertheless, we opted to use this SPI as our playback rhythm because we expected a natural SPI to elicit stronger responses than artificial or scrambled SPIs (Teyssède and Serrier, 1986). For each channel, the timing of EOD presentation started at a random point in the sequence. The SPI was then independently looped four times, yielding 2-min presentations per trial with

equal total numbers of energy-normalized EODs for each channel. Only the EOD waveform was experimentally varied between paired stimuli.

Experiments were performed at night (18.30–00.30 h) under infrared illumination provided by two IR lamps (2 W each; Sony model no. HVL-IRC). In each experiment, a male was subjected to four, 2-min playback trials. Each of the two signal pairs outlined above was presented in two trials. The orientation of signal presentation (left *versus* right) was reversed for the second trial with a given pair of EODs to control for side bias. We randomized the sequence in which the four resulting trials were presented and only started a trial after the male had returned to the central shelter and rested there for at least 60 s. Thus, the male's orientation was perpendicular to each playback bipole at the beginning of a trial (Fig. 3). Water in the playback aquariums was replaced with fresh, aerated water between males.

We videotaped outcomes of all playbacks using a Sony DCR-PC100 digital video camera. Playback aquariums were outfitted with two recording electrodes oriented orthogonally to the playback electrodes, which minimizes pick-up of playback EODs (Fig. 3). Signals from recording electrodes were amplified and captured in stereo on the audio tracks of miniDV video tapes (16-bit, 48 kHz). We scored responses of type I and type II males as either time spent or number of stereotyped bursts of EODs (e.g. Fig. 4C) produced within 10 cm of a given playback electrode. These bursts were characterized by constructing SPI plots using a threshold detection approach (Arnegard and Carlson, 2005). To facilitate

response scoring, we marked playback aquariums with 10-cm distance thresholds (Fig. 3), which we arbitrarily determined before beginning any experiments. We summed scores (either time or number of bursts) over each pair of trials in which the same set of EODs was played to a given individual. For each morph, we compared responses to paired EODs using Wilcoxon's signed-ranks tests (Sokal and Rohlf, 1998). We used one-tailed tests for these comparisons because we predicted greater responsiveness to homotypic EODs than to heterotypic or heterospecific EODs (Ryan and Rand, 1993). We also estimated the relative magnitude of responsiveness to homotypic EODs as the simple difference: response to the homotypic EOD minus response to the heterotypic (or heterospecific) EOD of the same stimulus pair. These relative response scores were compared between morphs using two-tailed Mann-Whitney *U* tests (Sokal and Rohlf, 1998). All statistical tests were performed using Statistica v.6.1 (StatSoft, Inc., Tulsa, OK, USA).

#### *Knollenorgan recordings: tuning characteristics and EOD coding*

Upon our return from Africa, we investigated tuning characteristics and signal-coding properties of Knollenorgan electroreceptors using type I and type II morphs previously captured from Mouvanga Creek (Fig. 2). Each individual was injected with 30  $\mu$ l of 0.75 mg ml<sup>-1</sup> Flaxedil to immobilize it and eliminate its EOD. A continuous stream of aerated water was passed across the gills for respiration. We used a previously established approach to deliver electrical stimuli to Knollenorgans and simultaneously record their spike-like receptor potentials non-invasively (Bennett, 1965; Hopkins and Bass, 1981). To do so, we used a wire electrode inside a Teflon tube, which we sealed over individual electroreceptor pores. With Knollenorgans enclosed in this way, spontaneous firing rates sometimes increased prior to external stimulation (range, 1.8–300 spikes s<sup>-1</sup>; mean  $\pm$  s.e.m., 65 $\pm$ 20 spikes s<sup>-1</sup>). The stimulus artifact was cancelled using a bridge circuit (Neuroprobe Amplifier, model 1600; A-M Systems, Inc., Carlsborg, WA, USA), and Knollenorgan spikes were detected using a Schmitt trigger. We used TDT System 3 hardware (Tucker-Davis Technologies Inc., Alachua, FL, USA) and custom software developed in Matlab to deliver stimulus waveforms (sampling rate 50 kHz) to the bridge circuit and record spike times at sub-microsecond resolution from the Schmitt trigger. Upon the conclusion of each experiment, the individual was returned to its home aquarium after it recovered from the Flaxedil.

Stimuli for estimating tuning characteristics of Knollenorgan electroreceptors consisted of tone bursts (250 Hz–5 kHz), each of which was played during a 90 ms test window. Tones were ramped on and off using cosine-squared windows of 5 ms duration before and after each test window. The number of receptor spikes during the 90-ms test window was compared to the number of spontaneous spikes in a 90-ms reference window, which began 85 ms after the test window. The threshold at each frequency was determined by finding the

minimum stimulus amplitude that elicited two more spikes, on average, in the test window than in the reference window. We also characterized the response properties of Knollenorgans by obtaining their reverse correlation (revcor) filters (de Boer and de Jongh, 1978; Rieke et al., 1997). To do so, we stimulated each Knollenorgan with Gaussian white noise and averaged all of the noise segments that immediately preceded receptor spikes. The resulting average waveform (i.e. the revcor filter) approximates the linear tuning properties of that receptor; it is essentially the waveform that best stimulates the receptor. The magnitude spectrum was calculated for each revcor filter and plotted upside down to visualize Knollenorgan tuning in the frequency domain. We smoothed each inverted magnitude spectrum using a three-point, unweighted average before determining each unit's best response frequency.

Stimuli for examining the coding of EOD waveforms by Knollenorgans consisted of EODs recorded from the type I, type II and type III morphs from various regions of Gabon. Knowledge of EOD waveform coding requires investigation of Knollenorgan responses to both polarities of a stimulus EOD (Hopkins and Bass, 1981; Xu-Friedman and Hopkins, 1999). At any given stimulus amplitude, peristimulus time (PST) histograms of receptor spikes were constructed using data from 300 presentations of an EOD waveform in one polarity (ten EODs per second for 30 s). Knollenorgans were also stimulated with an inverse polarity copy of the EOD at the same amplitude to construct a second PST histogram. Compound (cPST) histograms – formed by inverting the second histogram and plotting it together with the first – were used to qualitatively compare the same unit's response to different stimulus waveforms. This approach was also used to compare responses of similarly tuned Knollenorgans between morphs.

## Results

### *Responses of breeding males to playback of female-like EODs*

Outside of the experimental trials, males spent little time near the playback electrodes and typically remained in their central shelter. During the trials, type I and type II males responded vigorously to the playbacks. Both morphs rapidly approached the playback electrodes, investigating or circling them and occasionally butting them with their heads. Biting at the electrodes appeared to accompany some of these head-butting events. Simultaneously, males produced bursts of EODs similar to the 'SID' displays of other electric fishes (Black-Cleworth, 1970; Carlson, 2002). These brief bursts were characterized by a sudden drop in inter-discharge-interval to 8–12 ms, followed by a slower increase to 15–20 ms or more (Fig. 4C,D). Burst duration ranged from 200 to 500 ms. While rapidly approaching the electrode, males often ceased discharging for 0.5–3 s immediately before producing one or more bursts (e.g. Fig. 4E). Males only produced bursts during the playbacks and, then, only when they were within 10 cm of either electrode. Regardless of playback EODs, males typically approached each electrode multiple times during any 2-min

trial, suggesting that our experimental paradigm effectively presented males with a simultaneous and sustained 'choice' of responding to either signal.

When stimulated with type II and type I female EODs, type II males spent more time (Fig. 5A;  $T=4.0$ ;  $P=0.0050$ ; one-sided) and produced more bursts (Fig. 5C;  $T=9.0$ ;  $P=0.0164$ ) in the vicinity of type II EODs. When homotypic EODs were paired with heterospecific EODs recorded from 'CAB' females, homotypic EODs also elicited a greater response from type II males in terms of time spent within 10 cm of the playback electrode (Fig. 5A;  $T=9.5$ ;  $P=0.0333$ ). However, type II males did not differ in terms of the number of bursts produced in response to homotypic *versus* 'CAB' EODs (Fig. 5C;  $T=14.0$ ;  $P=0.1570$ ). In contrast to the discriminating response of type II males, type I males responded similarly to homotypic and heterotypic EODs in terms of time spent (Fig. 5B;  $T=38.5$ ;  $P=0.4844$ ) and number of bursts produced (Fig. 5D;  $T=26.5$ ;  $P=0.4594$ ) in the vicinity of the playback electrodes. During paired playback of EODs recorded from homotypic and 'CAB' females, type I males appeared to spend more time (Fig. 5B;  $T=18.5$ ;  $P=0.0539$ ) and direct more bursts towards homotypic

female EODs (Fig. 5D;  $T=13.5$ ;  $P=0.0415$ ; one-sided), but these differences were only marginally significant.

The type II and type I morphs differed in the relative magnitude of responsiveness to their own (i.e. homotypic) EODs ( $U=31.0$ ;  $P=0.0312$ ; two-sided test). When presented with type I and type II EODs simultaneously, type II males displayed on average a greater relative preference for type II EODs (in terms of proximity to the electrodes) than did type I males for type I EODs. The direction of this preference asymmetry was the same for burst production, although the difference was only marginally significant ( $U=36.0$ ;  $P=0.0648$ ). No differences were found between morphs in terms of the relative strength of responsiveness to homotypic EODs when these were presented with those of 'CAB' ( $U=63.5$  and  $P=0.8777$  for time;  $U=59.0$  and  $P=0.6666$  for bursts; two-sided). In summary, results of the playback experiments rejected the null hypothesis that type II males cannot discriminate *magnostipes*-complex EODs. They further revealed a difference in responsiveness of type I compared with type II males from the Ivindo River to playback of homotypic *versus* heterotypic EODs.

#### Breeding adult size

Given the broad size range of juvenile to adult individuals collected during past field efforts, we had previously been unable to distinguish sympatric *magnostipes*-complex morphs based on body shape or size. In the present study, we began noticing a tendency for type I breeding males to be larger than type II breeding males. Therefore, collections of breeding individuals were increased due to the possible role that a body size difference might play in the asymmetric responses

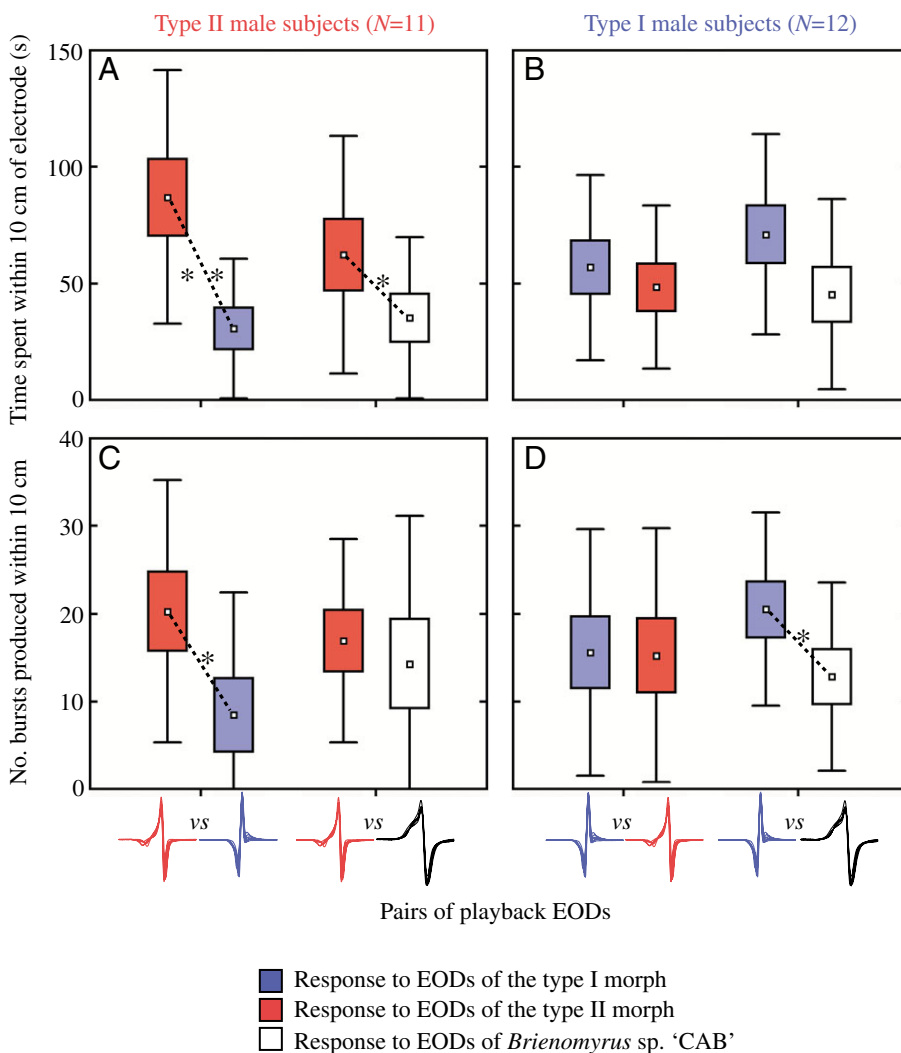

Fig. 5. Male responses to paired playbacks of female EODs. Responses are total amount of time males spent within 10 cm of a given playback electrode (A,B) and total number of bursts produced by the same males within 10 cm (C,D). Ordinate values are sums over each pair of trials in which the same set of EODs was presented to a subject. Results are shown separately for type II males (left panels) and type I males (right panels). Box-and-whisker plots are color coded to the playback EODs (shown at the bottom as overlays of amplitude-normalized voltage traces, each 2 ms in total duration). Small squares are mean responses; vertical ranges of rectangles are means  $\pm$  s.e.m.; and whiskers are means  $\pm$  s.d. Means connected by dotted lines differ significantly: \* $P<0.05$ ; \*\* $P<0.01$ .



of males to playbacks. Breeding males were found to be significantly larger than gravid females within each morph (Fig. 6;  $t_{37}=8.25$  and  $P<0.0001$  for type I;  $t_{57}=6.50$  and  $P<0.0001$  for type II; one-sided tests). Given the increased sampling, we found a significant difference in size between Type I and Type II males (Fig. 6;  $t_{55}=4.97$ ;  $P<0.0001$ ; two-sided). Congruent with the result for males, the mean SL of gravid type I females was larger than that of gravid type II females, but the difference was marginally insignificant ( $t_{39}=1.80$ ;  $P=0.0788$ ; two-sided). In addition to these comparisons from the Makokou region, the largest few individuals ever collected in the past from any other location where two morphs coexist in relatively even numbers (Fig. 2) have always been type I males (i.e. 1–3 individuals out of a total of 10–105, depending on collection locality). This holds true for Mouvanga Creek, the Okano River and a site at the confluence of the Upper Ogooué and Passa Rivers (M.E.A., unpublished), despite the fact that breeding adults were not targeted during these collections.

Assuming risk of injury is proportional to opponent size, some portion of the asymmetry in playback responses may be partly explained by the body size difference between morphs and the fact that some full-sized males collected during the breeding season exhibited female-like EODs (M.E.A., unpublished). When presented with type I and type II EODs, the smaller males (type II) spent less absolute time in proximity to type I EODs than did the larger, type I males (Fig. 5;  $U=38.5$ ;  $P=0.0453$ ; one-sided Mann–Whitney  $U$  test). Despite asymmetries in both male size and unconditioned responsiveness to paired playbacks, the preference of type II males for type II EODs indicates at least some degree of EOD discrimination among genetically indistinguishable sympatric morphs. Given this evidence and what is known about mormyrid electroreception, we expected to find distinct patterns of waveform encoding at the receptor level in response to different EOD types.

#### Knollenorgan recordings: tuning characteristics and EOD coding

By qualitative comparison to threshold tuning curves, magnitude spectra of revcor filters (plotted upside down) offer good estimates of Knollenorgan tuning (e.g. Fig. 7). Considering revcor filter spectra for all units, Knollenorgans were broadly tuned in both the type I and type II morphs from Mouvanga Creek (Fig. 8). Ranges of best response frequencies were 650–2501 Hz in type I (mean=1180 Hz;  $N=12$ ) and

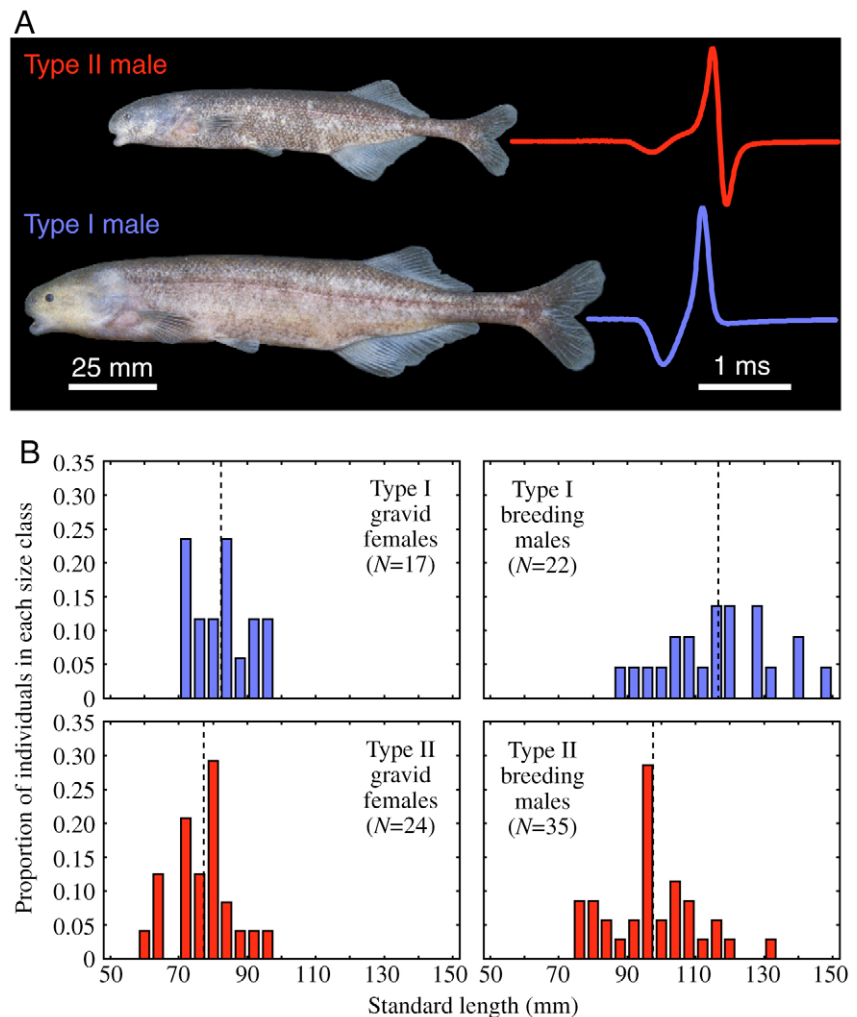

Fig. 6. Adult sizes of sympatric *magnostipes*-complex morphs from the Makokou region of the Ivindo River. (A) Photographs of a type II male (above; specimen 5945; SL=105 mm) and a type I male (below; specimen 5944; SL=147 mm) collected from Loa-Loa Rapids, showing their elongated EODs. (B) Distributions of standard lengths for gravid females and breeding males of both morphs ( $N$ =number of individuals; bin width=4 mm; means given as broken vertical lines).

800–5353 Hz in type II (mean=1926 Hz;  $N=10$ ). Distinct populations of low- (<1 kHz) and high- (>1 kHz) frequency Knollenorgans have been reported for *Brienomyrus* sp. 'VAD', which was formerly called *Brienomyrus* sp. 2 (Alves-Gomes and Hopkins, 1997; Sullivan et al., 2000; Lavoué et al., 2003) or *Brienomyrus brachyistius* 'triphasic' (*tp.*) (Hopkins, 1983; Bass and Hopkins, 1984). We did not record a sufficient number of units to rigorously investigate whether different populations of Knollenorgans are expressed within the morphs. The noticeably higher tuning of two units in a single type II individual (Fig. 8) suggests that such a division of Knollenorgans might also exist within the *magnostipes* complex. Mean best frequencies of all units did not differ significantly between morphs ( $t_{20}=1.44$ ;  $P=0.1646$ ; two-sided), yet we recognize that the power of this comparison is constrained by our limited number of samples. Nevertheless,

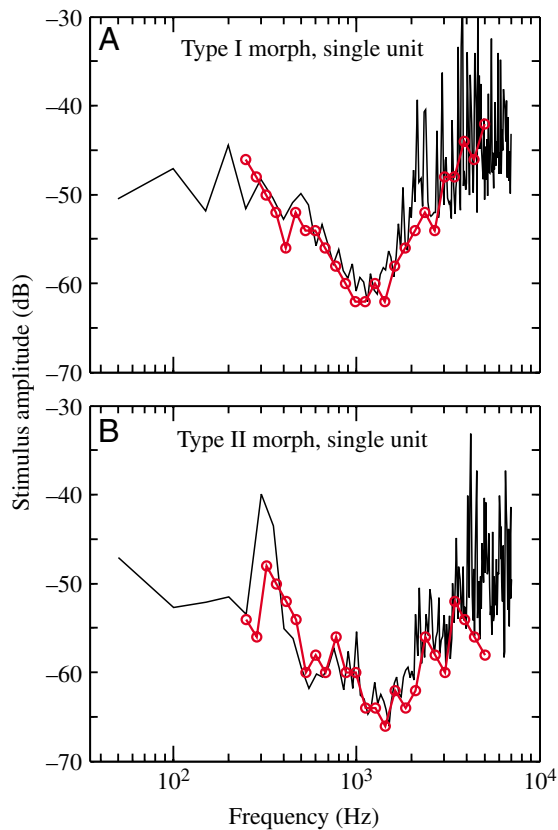

Fig. 7. Results of two methods for characterizing tuning properties of Knollenorgan electroreceptors. Frequency responses are shown for a single Knollenorgan in either type I (A; specimen 3) or type II (B; specimen 5). Red plots show threshold tuning curves. Black plots show magnitude spectra of revcor filters (computed for the same units; plotted upside down; not smoothed in these cases). Each spectrum is aligned vertically to the corresponding tuning curve for comparison.

it is worth noting that the mean best frequency in type II (1125 Hz) was almost identical to that in type I (1180 Hz) after excluding the two highest frequency units.

Knollenorgan spikes tended to time lock to rapid, outside-positive going edges or voltage changes within EOD waveforms. Regardless of which EOD was presented, receptor spikes became increasingly time-locked as stimulus amplitude increased. In the examples shown in Fig. 9, each plot gives Knollenorgan responses to the EOD waveform shown in red (positive going PST histogram) and to an inverted copy of the same EOD (negative going PST histogram). At sufficiently high stimulus amplitudes, spike jitter around the largest N→P transient in the type I EOD (i.e. the voltage change between the first and second EOD peaks) dropped to <25  $\mu$ s, or to within a single bin of the cPST histogram. However, there were brief delays between slope maxima of EOD waveforms and corresponding peak spiking times. In response to some waveform transients, the length of these delays decreased

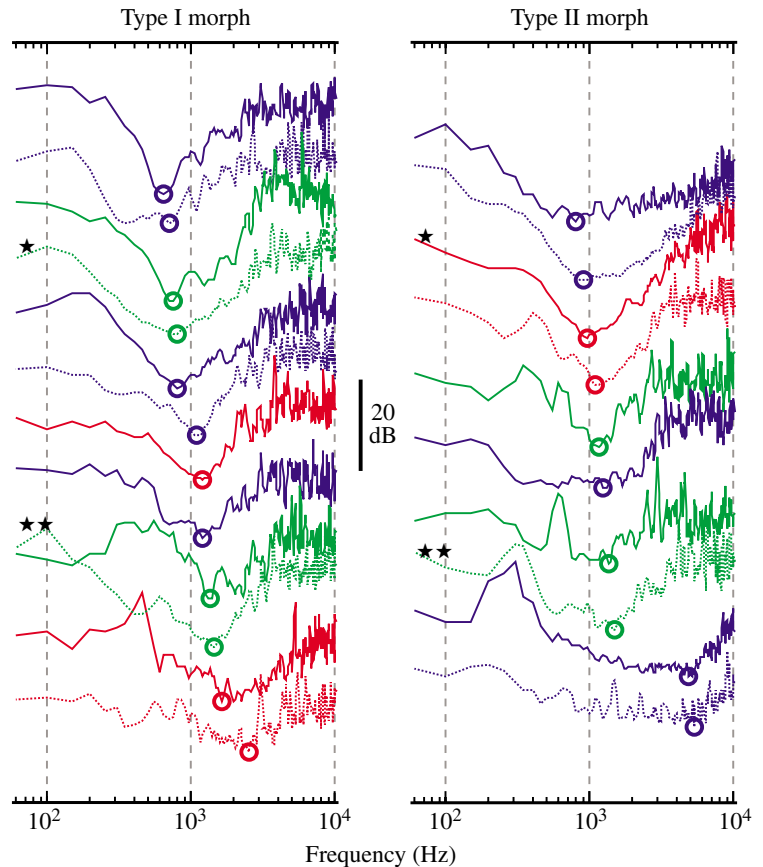

Fig. 8. Knollenorgan tuning estimated by upside-down plots of amplitude spectra of revcor filters for type I individuals (left) and type II individuals (right). Revcor filter spectra were smoothed using an unweighted three-point average, scaled the same with respect to power (20 dB scale bar indicated) and shifted by an arbitrary amount along the vertical axis to avoid overlap. A circle highlights the best response frequency of each unit. Each spectrum corresponds to a unique receptor. Knollenorgans in the type I morph: specimen 1, SL=94.5 mm, adult female or non-breeding male (blue); specimen 4, SL=107 mm, dominant male (green); specimen 3, SL=92 mm, adult female or non-breeding male (red). Knollenorgans in the type II morph: specimen 6, SL=76 mm, adult female or non-breeding male (blue); specimen 2, SL=87.5 mm, adult female or non-breeding male (red); specimen 5, SL=94.5 mm, adult female or non-breeding male (green). One star indicates receptors described in Fig. 9A,B; two stars correspond to Fig. 9C,D.

slightly with increasing stimulus amplitude. Given our non-invasive recording method, we are unable to report absolute field strengths corresponding to the amplitude levels provided in Fig. 9.

At a given amplitude, we found that a single *magnostipes*-complex EOD elicited a similar pattern of receptor spiking in both type I and type II individuals when we compared Knollenorgans with similar best frequencies. Furthermore, distinctive patterns of Knollenorgan spiking occurred in response to the different EOD types that characterize the *magnostipes* complex. Type I EODs of females and non-breeding males caused Knollenorgans to fire one time-locked spike in response to each stimulus polarity (Fig. 9).

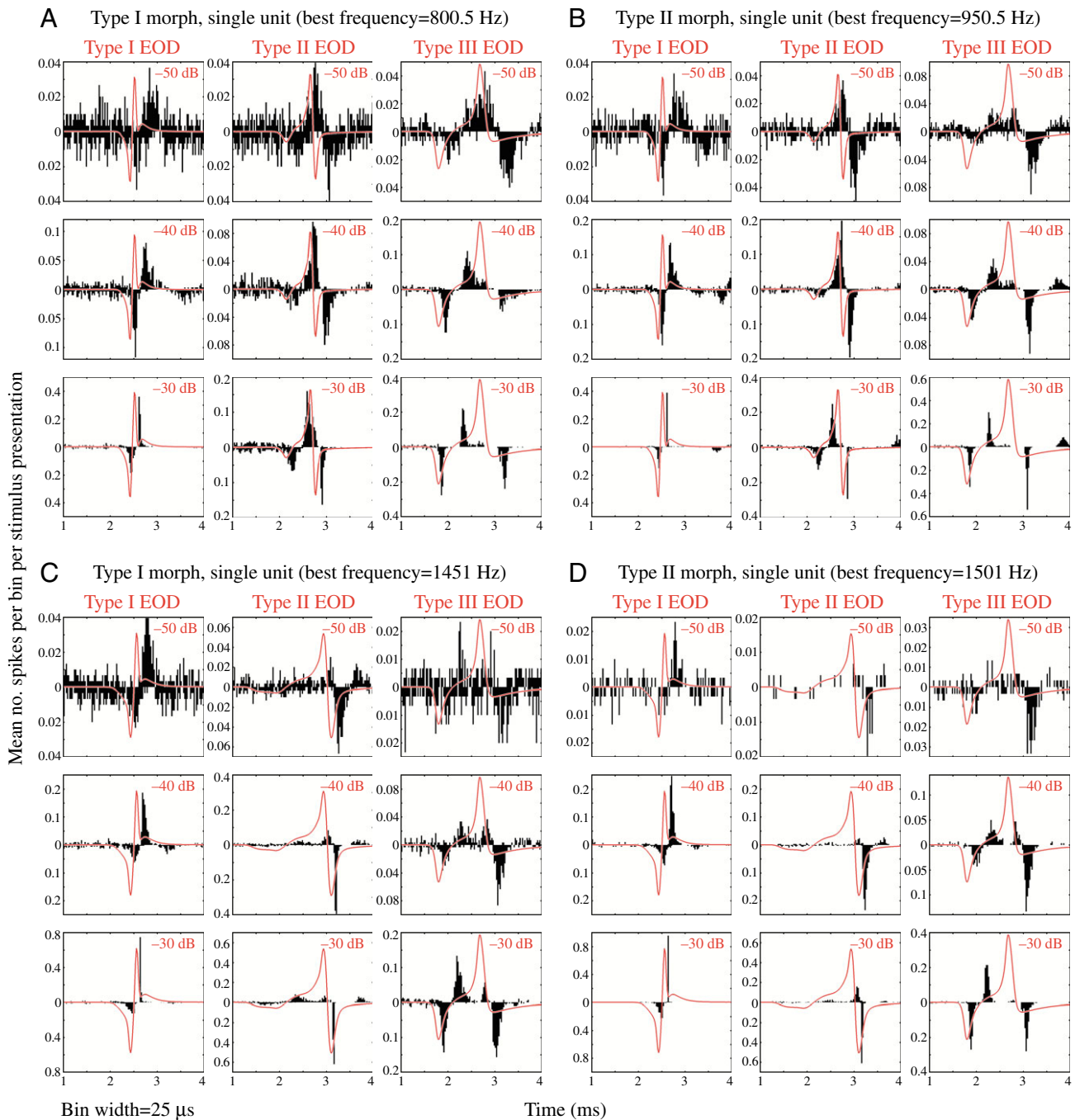

Fig. 9. Examples of Knollenorgan responses to natural EOD stimuli. Results are shown for electroreceptors with relatively low best frequencies in the type I morph (A; specimen 4) and the type II morph (B; specimen 2), as well as electroreceptors tuned to higher frequencies in the type I morph (C; a different unit in specimen 4) and the type II morph (D; specimen 5). Stimuli (red) are plotted on the same time axis as compound PST histograms of spike-like receptor potentials (black). In each sub-plot, the upward histogram gives responses to the EOD polarity shown, whereas the inverted stimulus was used to generate each downward histogram. Within each panel (A–D), the same stimulus waveforms are aligned vertically and are shown from lower (top) to higher (bottom) stimulus amplitudes (dB indicated). Identical stimulus waveforms (played to each morph) are shown in A,B, and a different set of identical waveforms is shown in C,D. The type II stimulus for A,B is a female-like EOD recorded from the Ivindo River. The type II stimulus for C,D is an EOD recorded from a Mouvanga Creek male exhibiting a slight degree of waveform elongation. All type III stimuli are the same EOD of an Okano River adult (sex and breeding status undetermined). Type I stimuli are female-like EODs (recorded from different individuals in A,B *versus* C,D).

Knollenorgan responses to elongated EODs of type I breeding males varied depending on the degree to which the stimulus waveforms had elongated and changed (data not shown). Presentation of EODs produced by the type III morph resulted in three or four time-locked spikes (Fig. 9). Two negative peaks in the cPST histogram occurred invariably in response to the inverse polarity presentation of a type III EOD at sufficient amplitude. Either one or two response peaks occurred with positive polarity presentation of a type III EOD, depending on Knollenorgan tuning and stimulus amplitude.

Geographic variation described for type II EODs (Arnegard et al., 2005) was reflected in patterns of Knollenorgan response. EODs of the type II morph have a much smaller initial head-negative peak than those of the type I morph or the Okano River population of the type III morph. Type II EODs of the Ivindo River population elicited three preferred spike times at high enough stimulus amplitudes, with some Knollenorgan spikes locked fairly well to the sharp, initial head-negative peak (Fig. 9A,B). On the other hand, type II EODs typical of Mouvanga Creek are characterized by a much broader initial peak (e.g. red traces in Fig. 9C,D) [see also Arnegard et al. (Arnegard et al., 2005)]. Inverse-polarity presentation of these type II EOD variants resulted in very weak time locking to the broad initial peak but tight time locking to the largest voltage transient in the waveform (Fig. 9C,D). Knollenorgan spikes tended to occur at several temporal positions during positive-polarity presentation of type II EODs from Mouvanga Creek, due to the relatively slow transition between the initial head-negative peak and the first head-positive peak. In the case of both Mouvanga Creek and the Ivindo River, patterns of Knollenorgan spiking in response to EODs of the type II morph differed from those elicited by EODs of the alternate co-occurring morph (type I).

### Discussion

Responses of breeding males to paired stimuli in our playback paradigm provided the first evidence that at least some members of the *magnostipes* complex can discriminate dimorphic signals characterizing this group of electric fishes. Our experiments controlled for the SPI and excluded all non-electrical cues that might co-vary with species- or morph-specific EODs. One likely function of the Knollenorgan pathway is the discrimination of temporal waveform features for the purpose of species and sex recognition. According to the current model for EOD analysis in the midbrain (Xu-Friedman and Hopkins, 1999), discrimination in our behavioral tests would require Knollenorgans to respond to waveform features that vary among signal classes of the *magnostipes* complex.

We found Knollenorgans in type I and type II morphs from Mouvanga Creek to be broadly tuned and exhibit best frequencies that could not be statistically distinguished between morphs. The range of best frequencies we estimated generally encompasses peak-amplitude frequencies of

*magnostipes*-complex EODs at this site (data not shown), as well as those of type I and type II morphs elsewhere in Gabon (Table 1). Any comparably tuned Knollenorgan in either morph encodes a particular EOD waveform with a similar pattern of spikes, which are time-locked (with delay) to outside-positive going (N→P) transients in the stimulus waveform. Rather than coding amplitude, Knollenorgan spikes reliably mark the timing of rapid, and sufficiently large, voltage changes in the EOD waveform (Bennett, 1971b; Hopkins, 1986; Amagai et al., 1998). In light of our playback evidence for waveform discrimination, the similarity of Knollenorgan tuning and EOD encoding between morphs suggests that signal discrimination can evolve without pre-existing biases at the receptor level (cf. Ryan, 1990; Endler and Basolo, 1998; Wilczynski et al., 2001).

Increasing signal amplitude improves the time locking of Knollenorgan spikes to EOD waveform features. Compared with mormyromast electroreceptors, spike-like receptor potentials of Knollenorgans occur at relatively fixed latencies to suprathreshold stimuli (Bennett, 1971b; Szabo and Fessard, 1974). However, an increase in EOD amplitude can slightly advance the timing of peaks in Knollenorgan spiking and often changes the relative probability of spiking at the different response peaks, particularly those corresponding to minor or gradual waveform features. Electric field strength drops off sharply as the distance between signaler and receiver increases (Knudsen, 1975). Therefore, overt behavioral interactions between mormyrids, such as anti-parallel displays, in which each of two individuals positions its head as close as possible to the other individual's electric organ [e.g. fig. 2 of Bell et al. (Bell et al., 1974)], may facilitate encoding of finer waveform features by ensuring high and constant signal amplitude. The mormyrid morphs in the present study also exhibit anti-parallel behaviors in certain contexts (M.E.A., unpublished). The waveform-specific patterns of receptor responses we describe were generated by averaging over repeated stimulus presentations. Time-coding pathways may achieve a similar result through convergence and spatial averaging at one or more levels in the central nervous system (e.g. Carr et al., 1986). Modest convergence has already been found at the first central relay of the Knollenorgan pathway (Bell and Grant, 1989). The possibility of further convergence at the level of nucleus extrolateralis pars anterior (ELA) warrants consideration.

Within each morph of the *magnostipes* complex, females and non-breeding males produce similar EODs that are distinctive from those of the other morphs. During the course of the present study, we recorded seasonally elongated EODs from numerous type I and type II males captured from the Ivindo River (Fig. 1). Male EODs in a transitional state of elongation were also encountered. Waveshapes of these transitional EODs resemble shorter-duration EODs produced by females of the same morph, and they grade into the fully altered EODs of males in peak breeding condition. As with females, time-domain EODs of males remain completely distinct between alternate sympatric morphs, despite seasonal waveform changes (Fig. 1). If the receiving individual knows the direction in which the sender is



facing (e.g. by means of tactile cues during anti-parallel displays), then differences in receptor responses to EODs of alternate sympatric morphs, whether male or female, become even more obvious than our Knollenorgan recordings might suggest. Type I and type II senders in the same position and orientation often cause the strongest (or most tightly time-locked) Knollenorgan responses to occur on opposite sides of the receiver's body (e.g. Fig. 9C,D).

Phase sensitivity has been previously demonstrated in weakly electric fish through experiments that transform an EOD in a manner that preserves its amplitude spectrum while adding a scalar angle ( $\phi$ ) to all positive frequencies of its phase spectrum and subtracting the same angle from all negative frequencies (Heiligenberg and Altes, 1978; Hopkins and Bass, 1981) (see Fig. 10). Inverse Fourier transformation using the new phase spectrum yields a temporally altered waveform. A  $\phi=180^\circ$  phase shift of this kind inverts the original EOD (Fig. 10B). Relative to the receiver, inversion of an EOD also occurs when the sender simply turns and faces the opposite direction. Considering the range  $0^\circ \leq \phi \leq 180^\circ$  and disregarding sender orientation, a  $\phi=90^\circ$  phase shift maximizes the following measure of deviation,  $D[V_\phi(t), V(t)]$ , between the original or reference EOD,  $V(t)$ , and the phase-shifted EOD,  $V_\phi(t)$ , over both polarities of  $V(t)$  and all possible temporal alignments ( $d$ ) of one waveform to the other:

$$D[V_\phi(t), V(t)] = \min_d \left\{ \sum_t [V_\phi(t) - V(t-d)]^2, \sum_t [V_\phi(t) + V(t-d)]^2 \right\}.$$

Here,  $V$  and  $t$  represent voltage and time, respectively, and both

Fig. 10. Spectral phase shifts of *magnostipes*-complex EODs. (A) Example reference EODs acquired as DC recordings of type I and type II males from the Ivindo River (total duration of each trace=4 ms). (B) Multiple overlays, each showing a phase-shifted EOD (red; type I from A) on top of one of the unaltered, reference EODs (black). Phase shift angle is given as  $\phi$  (see text for details). The reference EOD is plotted in the polarity and temporal alignment that minimizes the total squared deviation between it and the phase-shifted EOD (i.e. it is allowed to invert freely; see asterisks). In the left column of B, the type I EOD is compared to phase-shifted versions of itself. In the right column, the phase-shifted type I EOD is compared to the type II reference EOD. (C) Minimum total squared deviation (across  $\phi$ ) for best alignments between phase-shifted and reference EODs [i.e.  $D[V_\phi(t), V(t)]$ ; defined in the text]. All deviations are scaled from 0 to 1 for each family of comparisons with a given pair of EODs across  $\phi$ . Filled red squares are from comparisons shown in B. The plot at the right also shows 15 randomly selected comparisons between male EODs of the type I and type II morphs from the Ivindo River. For each comparison, the type I EOD was phase shifted and the type II EOD served as the reference (open squares) and *vice versa* (filled circles). (D) Distribution of angles ( $\phi$ ) providing the best fit between phase-shifted male EODs of one morph and unaltered male EODs of the other morph (for all comparisons in C, right plot).

waveforms are assumed to be sampled at the same rate. As illustrated in Fig. 10B,C (left column), a  $\phi=90^\circ$  transformation of the kind described results in the largest alteration in time-

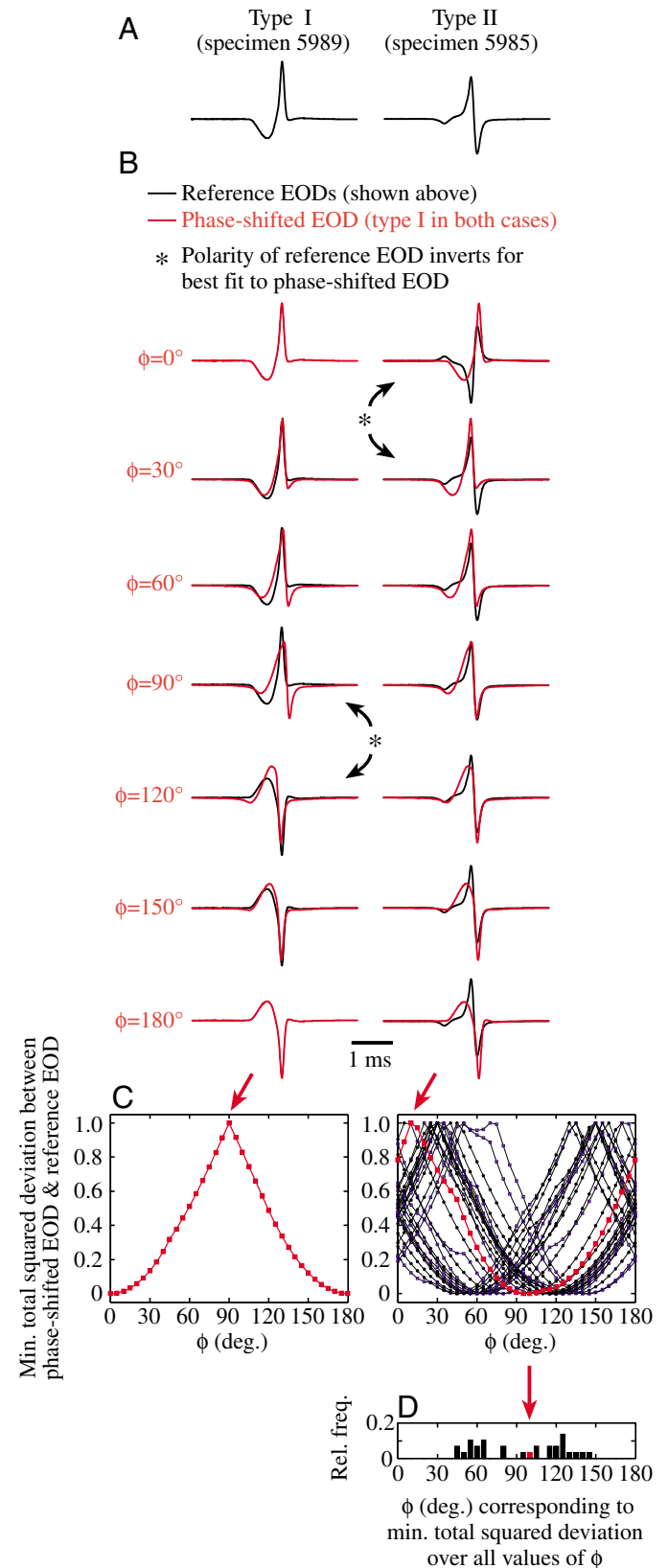

domain structure of any given EOD. Characteristic EODs of breeding males do not vary noticeably in amplitude spectra between type I and type II morphs from the Ivindo River (Fig. 1; Table 1). By contrast, when randomly selected male EODs of one of these morphs are compared to phase-altered male EODs of the other morph (e.g. Fig. 10B, right column), phase shift angles of 45–145° tend to yield the best fit between waveforms (Fig. 10C, right plot). While most values of  $\phi$  that minimize the total squared deviation between waveforms are centered around 60° and 120°, some fall close to 90° (Fig. 10D). Applied to female EODs of *Brienomyrus* sp. 'VAD', phase shift angles in this same range maximally inhibited evoked courtship rasps during playbacks to males on their well-spaced territories in the extreme headwaters of an Ivindo River tributary (Hopkins and Bass, 1981). Thus, EOD divergence between males of the two *magnostipes*-complex morphs from the Ivindo River appears to be designed for distinctiveness in the time domain, while simultaneously requiring no change in Knollenorgan tuning.

Coding of EODs by the Knollenorgan pathway is thought to involve a comparison of the timing of receptor spikes in opposite body regions (e.g. head *versus* tail or right *versus* left), which respond to oppositely directed transients in the same EOD (i.e. positive going or negative going) due to the different directions of current flow with respect to the inside of the animal (Amagai, 1998; Amagai et al., 1998; Friedman and Hopkins, 1998). In the simplest version of this model, midbrain analysis of latencies between two spikes generated by Knollenorgans in opposing body regions mediates estimation of EOD duration (Hopkins and Bass, 1981). In the present study, we show that EODs produced by either the type II or type III morph elicit patterns of Knollenorgan spiking that are more complex than a simple two-spike response. EODs of other *Brienomyrus* species from Gabon are also known to be coded at the periphery by relatively complex patterns of Knollenorgan spiking [see Hopkins, p. 567 (Hopkins, 1986)].

Excluding the focal morphs, whose status as biological species remains uncertain, 10 other species of Gabon-clade *Brienomyrus* occur at the most species-rich locality known for this group: Loa-Loa Rapids (Arnegard et al., 2005). Any *Brienomyrus* species (or morph) is likely to experience differing levels of aggressive threat, niche overlap or reproductive competition from the other species (and morphs) with which it co-occurs. To the extent that this holds true, recognition of numerous kinds of EOD waveforms is expected to be adaptive. A locus for such recognition would require integration of multiple latencies between spikes generated by populations of Knollenorgans residing in opposite body regions. A candidate site for this integration is nucleus extrolateralis pars posterior (ELp) (Haugedé-Carré, 1979; Amagai, 1998; Friedman and Hopkins, 1998). However, because Knollenorgan responses to EODs vary predictably with orientation of a sender and its distance from the receiver, recognition may involve other sensory modalities providing information on sender position (Moller, 2002). Alternate loci for EOD template matching, if it occurs, are the higher centers

that receive input from ELp as well as other sensory systems (see Xu-Friedman and Hopkins, 1999).

Wave-type gymnotiform and mormyrid fish are sensitive to temporal disparities between signals from different body regions in the microsecond to sub-microsecond range (Carr et al., 1986; Kawasaki and Guo, 1996). 'Dear enemy' recognition of conspecifics based on very slight differences in EOD waveforms is known from laboratory studies with pulse-type species in both taxonomic groups (McGregor and Westby, 1992; Hanika and Kramer, 2005). Using a conditioned discrimination task, Paintner and Kramer recently demonstrated that the mormyrid, *Pollimyrus adspersus*, can distinguish EODs varying only in phase spectra (Paintner and Kramer, 2003). Why, then, did we only find moderate evidence for discrimination of large temporal differences in EOD waveforms?

Our design for the first playback study aimed at this system was based on an expectation that breeding males would preferentially respond to homotypic EODs, at least when they were paired against heterospecific EODs of a reproductively isolated, sympatric species. We reasoned that homotypic EODs would serve as 'marker traits' (e.g. Bolnick and Doebeli, 2003) for the presence of reproductive competitors or fitness-enhancing spawning opportunities. In general, a functional role for EODs as species markers is suggested by patterns of sympatric waveform variation among other members of Gabon's *Brienomyrus* species flock. However, statistically significant support for our expectation was only found for one of two correlated responses by type I (i.e. rate of burst production) and type II (i.e. proximity) when homotypic EODs were presented together with those of 'CAB'. Social isolation may have partially masked the EOD preferences we expected to find. Mormyrids are known to respond to a variety of electrical playbacks, including artificial stimuli such as brief square waves (Kramer, 1990; Moller, 1995). Type I and type II males almost invariably responded vigorously to both paired signals during any playback trial. Confining males in playback chambers may have exaggerated a novelty response in these subjects to any EOD stimulus at all.

When female EODs of alternate *magnostipes*-complex morphs were played as pairs, only type II males exhibited preferential responses to homotypic EODs. Because we have not directly observed spawning by morphs of the *magnostipes* complex, we have no knowledge of SPI patterns during courtship sequences in this group (cf. Hopkins and Bass, 1981; Carlson and Hopkins, 2004). Therefore, we caution that the observed asymmetry in response between morphs should not currently be interpreted as an actual asymmetry in male mating preference. In addition to the stress of social isolation and/or any genuine male mating preferences that may be present, outcomes of our playback experiments could have been influenced by male–male interactions such as aggression and territoriality (Maan et al., 2004; Dijkstra et al., 2006). Although we presented female-like EODs to isolated males soon after capture, responses exhibited by both type I and type II males included head butting and biting directed at the electrodes (Bell

et al., 1974; Hanika and Kramer, 2005). Males also responded to playbacks by producing short bursts of EODs, often preceding them with brief cessations of electromotor output. Such displays are associated with overt aggression in a wide variety of mormyrid species (Kramer, 1979; Hopkins, 1986; Moller, 1995; Carlson, 2002).

Outcomes of agonistic encounters are strongly influenced by relative body size in many animals (Leimar et al., 1991; Hughes, 1996; Calsbeek and Sinervo, 2002; Lindström and Pampoulie, 2004), including mormyrids (Bell et al., 1974). Besides the anatomical correlates of EOD variation (e.g. Bass, 1986), body size is currently the only phenotypic character known to be associated with parallel cases of sympatric EOD divergence in the *magnostipes* complex. In the Ivindo River, breeding males of the type I morph are significantly larger than breeding males of the type II morph. Gravid females exhibit a trend in the same direction.

A statistically significant difference between the responses of type I and type II males to homotypic *versus* heterotypic EODs is consistent with an asymmetry in aggressive threat posed by the sympatric morphs. Type II males discriminated EODs and responded more vigorously to homotypic signals. Type I males failed to show differential responses to type I *versus* type II EODs. Based on the extreme genetic similarity of sympatric morphs, it is reasonable to hypothesize that electric organ discharge discrimination was masked in type I males. In the absence of other cues, EODs may provide insufficient information for reliable sex recognition within morphs because some adult males without elongated EODs can be found during the breeding season. With paired presentation of homotypic and heterotypic EODs, a novelty response to type I EODs (even though female-like in waveform) may have been suppressed in type II males due to a risk of aggression from the larger morph. By contrast, type I males may have been less inhibited from responding to novel signals of any waveform, potentially masking their discrimination of EODs in our experimental paradigm.

Beyond the stress of social isolation, other limitations of our study design likely affected our results. Mormyrids often interact in complex ways in terms of temporal patterns of electric organ discharge (Arnegard and Carlson, 2005). Lack of reciprocal SPI interactions during the playbacks probably heightened aggression, which males may have expressed concurrently with their mating preferences. It is also possible that a lack of sensory (e.g. tactile) cues regarding orientation of the fictive animal's head relative to the model electric organ (i.e. the playback bipole) contributed noise to our results. Use of model fish containing embedded electrodes should be considered in future playback experiments. Despite these limitations, our study has still yielded important initial indications that EOD diversification between sympatric morphs functions in communication. Different classes of *magnostipes*-complex EODs are precisely encoded at the periphery, and at least some members of this complex exhibit an ability to behaviorally discriminate these electrical displays. In the Makokou region, type II males appear more likely to

orient toward, and respond electrically to, female-like EODs of their own morph than to those of type I. Furthermore, the morphs are now known to differ behaviorally in their asymmetric responses to homotypic *versus* heterotypic EODs in the absence of all other sensory cues.

Consistent with the way in which stabilizing selection for species recognition affects signal design, EODs of adult females in several mormyrid assemblages are known for their interspecific variation and intraspecific stereotypy (Hopkins, 1999; Arnegard and Hopkins, 2003; Feulner et al., 2006). Despite the genetic similarity of co-occurring morphs of the *magnostipes* complex (Sullivan et al., 2002; Sullivan et al., 2004; Arnegard et al., 2005), the hypothesis that these forms are associated with an early stage of sympatric speciation in one or more populations warrants additional consideration due to this general pattern of EOD variation. Empirical results and theory suggest that divergence in traits such as body shape and size, resource use behaviors and/or microhabitat selection can accompany sympatric speciation under frequency-dependent ecological selection (Wood and Foote, 1996; Kondrashov and Kondrashov, 1999; Schliewen et al., 2001; Doebeli and Dieckmann, 2003; Barluenga et al., 2006). Male–male competition for access to females and perhaps other territorial resources may also influence signal divergence and sympatric lineage branching in important ways (Seehausen and Schluter, 2004; Dijkstra et al., 2005; Dijkstra et al., 2006). Nevertheless, the previous genetic data suggest that speciation has not occurred between the sympatric morphs (Arnegard et al., 2005). Instead, *magnostipes*-complex EODs may signal alternate behavioral or life history strategies (Roff, 2001). If so, geographic variation in the relative abundances of sympatric morphs may be due to influences of environmental and community heterogeneity on either the expression of a conditional strategy or the evolutionarily optimal frequencies of alternate fixed strategies (e.g. Svensson and Sinervo, 2004). The above possibilities are not exhaustive, nor are they mutually exclusive (West-Eberhard, 2003).

Based on our playbacks to isolated males of the *magnostipes* complex, EODs of this group appear to function in morph-specific advertisement and recognition. Improved playback designs targeting conditioned responses or employing more natural contexts for social groups of test subjects are needed to better understand the behavioral roles of EOD variation in the *magnostipes* complex. Knowledge of female mating preferences is also critically important to achieving this goal. In addition to initial evidence of a communication function for waveform variation, the existence of EOD dimorphisms in several, genetically isolated populations suggests that a deterministic mechanism (e.g. natural selection) is maintaining discrete signal variation or driving divergence along EOD lines (Schluter and Nagel, 1995). Unless population sizes are extremely large, it would be unlikely to find signal dimorphisms persisting in several isolated populations simultaneously if EOD waveform variation were selectively neutral. This pattern of multiple signal dimorphisms in the *magnostipes* complex informs us that EOD diversification can



either precede mormyrid lineage splitting or play an active role early in the speciation process, arising long before genome-wide genetic differences accumulate between sister species. Our finding of a size difference between co-occurring morphs provides an important framework for future experimental studies of the causes and consequences of EOD variation in this intriguing group of electric fishes.

At various stages of this work, we benefited from the insights and comments of Bruce Carlson, Rick Harrison, Jonathan King, Alex Kondrashov, Bruce Land, Amy McCune, Jordan Moore, H. Kern Reeve and John Sullivan. Bruce Land provided invaluable support for the design of our playback system, and Garry Harned helped us with figure preparation. Many thanks are also due to John Sullivan, Jean Ndong, Samba Ndong and Roger Kowe for tremendous assistance in Gabon under conditions that required fortitude at times during the rainy season. M.E.A. was supported by a training grant (NIMH 2 T32 MH15793) from the National Institutes of Health (NIH) and by a dissertation improvement grant (DEB-0104886) from the National Science Foundation (NSF). Additional grants to C.D.H. from NIH (DC006206) and NSF (DEB-0108372) supported critical components of this research.

### References

- Allender, C. J., Seehausen, O., Knight, M. E., Turner, G. F. and Maclean, N. (2003). Divergent selection during speciation of Lake Malawi cichlid fishes inferred from parallel radiations in nuptial coloration. *Proc. Natl. Acad. Sci. USA* **100**, 14074-14079.
- Alves-Gomes, J. and Hopkins, C. D. (1997). Molecular insights into the phylogeny of mormyrid fishes and the evolution of their electric organs. *Brain Behav. Evol.* **49**, 324-351.
- Amagai, S. (1998). Time coding in the midbrain of mormyrid electric fish. II. Stimulus selectivity in the nucleus extero-lateralis pars posterior. *J. Comp. Physiol. A* **182**, 131-143.
- Amagai, S., Friedman, M. A. and Hopkins, C. D. (1998). Time coding in the midbrain of mormyrid electric fish. I. Physiology and anatomy of cells in the nucleus extero-lateralis pars anterior. *J. Comp. Physiol. A* **182**, 115-130.
- Arnegard, M. E. and Carlson, B. A. (2005). Electric organ discharge patterns during group hunting by a mormyrid fish. *Proc. R. Soc. Lond. B Biol. Sci.* **272**, 1305-1314.
- Arnegard, M. E. and Hopkins, C. D. (2003). Electric signal variation among seven blunt-snouted *Brienomyrus* species (Teleostei: Mormyridae) from a riverine species flock in Gabon, Central Africa. *Environ. Biol. Fishes* **67**, 321-339.
- Arnegard, M. E., Bogdanowicz, S. M. and Hopkins, C. D. (2005). Multiple cases of striking genetic similarity between alternate electric fish signal morphs in sympatry. *Evolution* **59**, 324-343.
- Barluenga, M., Stöfling, K. N., Salzburger, W., Muschick, M. and Meyer, A. (2006). Sympatric speciation in Nicaraguan crater lake cichlid fish. *Nature* **439**, 719-723.
- Bass, A. H. (1986). Electric organs revisited: evolution of a vertebrate communication and orientation organ. In *Electroreception* (ed. T. H. Bullock and W. Heiligenberg), pp. 13-70. New York: John Wiley.
- Bass, A. H. and Hopkins, C. D. (1983). Hormonal control of sexual differentiation: changes in electric organ discharge waveform. *Science* **220**, 971-974.
- Bass, A. H. and Hopkins, C. D. (1984). Shifts in frequency tuning of electroreceptors in androgen-treated mormyrid fish. *J. Comp. Physiol. A* **155**, 713-724.
- Bass, A. H. and Hopkins, C. D. (1985). Hormonal control of sex differences in the electric organ discharge (EOD) of mormyrid fishes. *J. Comp. Physiol. A* **156**, 587-604.
- Bell, C. C. and Grant, K. (1989). Corollary discharge inhibition and preservation of temporal information in a sensory nucleus of mormyrid electric fish. *J. Neurosci.* **9**, 1029-1044.
- Bell, C. C., Myers, J. P. and Russell, C. J. (1974). Electric organ discharge patterns during dominance related behavioral displays in *Gnathonemus petersii* (Mormyridae). *J. Comp. Physiol.* **92**, 201-228.
- Bell, C. C., Bradbury, J. and Russell, C. J. (1976). The electric organ of a mormyrid as a current and voltage source. *J. Comp. Physiol.* **110**, 65-88.
- Bennett, M. V. L. (1965). Electroreceptors in mormyrids. *Cold Spring Harbor Symp. Quant. Biol.* **30**, 245-262.
- Bennett, M. V. L. (1971a). Electric organs. In *Fish Physiology*, Vol. 5 (ed. W. S. Hoar and D. J. Randall), pp. 347-491. New York: Academic Press.
- Bennett, M. V. L. (1971b). Electroreception. In *Fish Physiology*, Vol. 5 (ed. W. S. Hoar and D. J. Randall), pp. 493-574. New York: Academic Press.
- Black-Cleworth, P. (1970). The role of electrical discharges in the non-reproductive social behaviour of *Gymnotus carapo* (Gymnotidae, Pisces). *Anim. Behav. Monogr.* **3**, 1-77.
- Boden, G., Teugels, G. G. and Hopkins, C. D. (1997). A systematic revision of the large-scaled *Marcusenius* with description of a new species from Cameroon (Teleostei; Osteoglossomorpha; Mormyridae). *J. Nat. Hist.* **31**, 1645-1682.
- Bolnick, D. I. and Doebeli, M. (2003). Sexual dimorphism and adaptive speciation: two sides of the same ecological coin. *Evolution* **57**, 2433-2449.
- Calsbeek, R. and Sinervo, B. (2002). The ontogeny of territoriality during maturation. *Oecologia* **132**, 468-477.
- Caputi, A. A., Carlson, B. A. and Macadar, O. (2005). Electric organs and their control. In *Electroreception* (ed. T. H. Bullock, C. D. Hopkins, A. N. Popper and R. R. Fay), pp. 410-451. New York: Springer Science.
- Carlson, B. A. (2002). Electric signaling behavior and the mechanisms of electric organ discharge production in mormyrid fish. *J. Physiol. (Paris)* **96**, 405-419.
- Carlson, B. A. and Hopkins, C. D. (2004). Stereotyped temporal patterns in electrical communication. *Anim. Behav.* **68**, 867-878.
- Carr, C. E., Heiligenberg, W. and Rose, G. J. (1986). A time-comparison circuit in the electric fish midbrain. I. Behavior and physiology. *J. Neurosci.* **6**, 107-119.
- de Boer, E. and de Jongh, H. R. (1978). On cochlear encoding: potentialities and limitations of the reverse-correlation technique. *J. Acoust. Soc. Am.* **63**, 115-135.
- Dijkstra, P. D., Seehausen, O. and Groothuis, T. G. G. (2005). Direct male-male competition can facilitate invasion of new colour types in Lake Victoria cichlids. *Behav. Ecol. Sociobiol.* **58**, 136-143.
- Dijkstra, P. D., Seehausen, O., Gricar, B. L. A., Maan, M. E. and Groothuis, T. G. G. (2006). Can male-male competition stabilize speciation? A test in Lake Victoria haplochromine cichlid fish. *Behav. Ecol. Sociobiol.* **59**, 704-713.
- Doebeli, M. and Dieckmann, U. (2003). Speciation along environmental gradients. *Nature* **421**, 259-264.
- Endler, J. A. and Basolo, A. L. (1998). Sensory ecology, receiver biases and sexual selection. *Trends Ecol. Evol.* **13**, 415-420.
- Feulner, P. G. D., Kirschbaum, F., Schugardt, C., Ketmaier, V. and Tiedemann, R. (2006). Electrophysiological and molecular genetic evidence for sympatrically occurring cryptic species in African weakly electric fishes (Teleostei: Mormyridae: *Campylomormyrus*). *Mol. Phylogenet. Evol.* **39**, 198-208.
- Friedman, M. A. and Hopkins, C. D. (1998). Neural substrates for species recognition in the time-coding electrosensory pathway of mormyrid electric fish. *J. Neurosci.* **18**, 1171-1185.
- Gerhardt, H. C. and Huber, F. (2002). *Acoustic Communication in Insects and Anurans: Common Problems and Diverse Solutions*. Chicago: University of Chicago Press.
- Graff, C. and Kramer, B. (1992). Trained weakly-electric fishes *Pollimyrus isidori* and *Gnathonemus petersii* (Mormyridae, Teleostei) discriminate between waveforms of electric pulse discharges. *Ethology* **90**, 279-292.
- Hanika, S. and Kramer, B. (2005). Intra-male variability of its communication signal in the weakly electric fish, *Marcusenius macrolepidotus* (South African form), and possible functions. *Behaviour* **142**, 145-166.
- Haugedé-Carré, F. (1979). The mesencephalic extero-lateral posterior nucleus of the mormyrid fish *Brienomyrus niger*: efferent connections studied by the HRP method. *Brain Res.* **178**, 179-184.



- Heiligenberg, W. and Altes, R. A.** (1978). Phase sensitivity in electroreception. *Science* **199**, 1001-1004.
- Herfeld, S. and Moller, P.** (1998). Effects of 17  $\alpha$ -methyltestosterone on sexually dimorphic characters in the weakly discharging electric fish, *Brienomyrus niger* (Günther, 1866) (Mormyridae): electric organ discharge, ventral body wall indentation, and anal-fin ray bone expansion. *Horm. Behav.* **34**, 303-319.
- Hopkins, C. D.** (1981). On the diversity of electric signals in a community of mormyrid electric fish in West Africa. *Am. Zool.* **21**, 211-222.
- Hopkins, C. D.** (1983). Neuroethology of species recognition in electroreception. In *Advances in Vertebrate Neuroethology* (ed. J.-P. Ewert, R. R. Capranica and D. J. Ingle), pp. 871-881. New York: Plenum Press.
- Hopkins, C. D.** (1986). Behavior of Mormyridae. In *Electroreception* (ed. T. H. Bullock and W. Heiligenberg), pp. 527-576. New York: John Wiley.
- Hopkins, C. D.** (1999). Design features for electric communication. *J. Exp. Biol.* **202**, 1217-1228.
- Hopkins, C. D. and Bass, A. H.** (1981). Temporal coding of species recognition signals in an electric fish. *Science* **212**, 85-87.
- Hughes, M.** (1996). Size assessment via a visual signal in snapping shrimp. *Behav. Ecol. Sociobiol.* **38**, 51-57.
- Kawasaki, M. and Guo, Y.-X.** (1996). Neuronal circuitry for comparison of timing in the electrosensory lateral line lobe of the African wave-type electric fish *Gymnarchus niloticus*. *J. Neurosci.* **16**, 380-391.
- Knudsen, E. I.** (1975). Spatial aspects of the electric fields generated by weakly electric fish. *J. Comp. Physiol.* **99**, 103-118.
- Kondrashov, A. S. and Kondrashov, F. A.** (1999). Interactions among quantitative traits in the course of sympatric speciation. *Nature* **400**, 351-354.
- Kramer, B.** (1979). Electric and motor responses of the weakly electric fish, *Gnathonemus petersii* (Mormyridae), to play-back of social signals. *Behav. Ecol. Sociobiol.* **6**, 67-79.
- Kramer, B.** (1990). *Electrocommunication in Teleost Fishes: Behavior and Experiments*. Berlin: Springer-Verlag.
- Lavoué, S., Sullivan, J. P. and Hopkins, C. D.** (2003). Phylogenetic utility of the first two introns of the S7 ribosomal protein gene in African electric fishes (Mormyroidea: Teleostei) and congruence with other molecular markers. *Biol. J. Linn. Soc. Lond.* **78**, 273-292.
- Lavoué, S., Hopkins, C. D. and Kamdem Toham, A.** (2004). The *Petrocephalus* (Pisces, Osteoglossomorpha, Mormyridae) of Gabon, Central Africa, with the description of a new species. *Zoosystema* **26**, 511-535.
- Leimar, O., Austad, S. and Enquist, M.** (1991). A test of the sequential assessment game: fighting in the bowl and doily spider *Frontinella pyramitela*. *Evolution* **45**, 862-874.
- Lindström, K. and Pampoulie, C.** (2004). Effects of resource holding potential and resource value on tenure at nest sites in sand gobies. *Behav. Ecol.* **16**, 70-74.
- Maan, M. E., Seehausen, O., Söderberg, L., Johnson, L., Ripmeester, E. A. P., Mrosso, H. D. J., Taylor, M. I., van Dooren, T. J. M. and van Alphen, J. J. M.** (2004). Intraspecific sexual selection on a speciation trait, male coloration, in the Lake Victoria cichlid *Pundamilia nyererei*. *Proc. R. Soc. Lond. B Biol. Sci.* **271**, 2445-2452.
- Masta, S. E. and Maddison, W. P.** (2002). Sexual selection driving diversification in jumping spiders. *Proc. Natl. Acad. Sci. USA* **99**, 4442-4447.
- McGregor, P. K. and Westby, G. W. M.** (1992). Discrimination of individually characteristic electric organ discharges by a weakly electric fish. *Anim. Behav.* **43**, 977-986.
- Moller, P.** (1995). *Electric Fishes: History and Behavior*. New York: Chapman and Hall.
- Moller, P.** (2002). Multimodal sensory integration in weakly electric fish: a behavioral account. *J. Physiol. (Paris)* **96**, 547-556.
- Moller, P. and Szabo, T.** (1981). Lesions in the nucleus mesencephali extrolateralis: effects on electrocommunication in the mormyrid fish *Gnathonemus petersii* (Mormyridae). *J. Comp. Physiol. A* **144**, 327-333.
- Mugnaini, E. and Maler, L.** (1987). Cytology and immunocytochemistry of the nucleus of the lateral line lobe in the electric fish *Gnathonemus petersii* (Mormyridae): evidence suggesting that GABAergic synapses mediate an inhibitory corollary discharge. *Synapse* **1**, 32-56.
- Paintner, S. and Kramer, B.** (2003). Electrosensory basis for individual recognition in a weakly electric, mormyrid fish, *Pollimyrus adspersus* (Günther, 1866). *Behav. Ecol. Sociobiol.* **55**, 197-208.
- Rieke, F., Warland, D., de Ruyter van Steveninck, R. and Bialek, W.** (1997). *Spikes: Exploring the Neural Code*. Cambridge, MA: MIT Press.
- Roff, D. A.** (2001). *Life History Evolution*. Sunderland, MA: Sinauer.
- Ryan, M. J.** (1990). Sexual selection, sensory systems and sensory exploitation. In *Oxford Surveys in Evolutionary Biology*, Vol. 7 (ed. D. Futuyma and J. Antonovics), pp. 157-195. New York: Oxford University Press.
- Ryan, M. J. and Rand, A. S.** (1993). Species recognition and sexual selection as a unitary problem in animal communication. *Evolution* **47**, 647-657.
- Schliwien, U., Rassmann, K., Markmann, M., Markert, J., Kocher, T. and Tautz, D.** (2001). Genetic and ecological divergence of a monophyletic cichlid species pair under fully sympatric conditions in Lake Ejagham, Cameroon. *Mol. Ecol.* **10**, 1471-1488.
- Schluter, D. and Nagel, L. M.** (1995). Parallel speciation by natural selection. *Am. Nat.* **146**, 292-301.
- Seehausen, O. and Schluter, D.** (2004). Male-male competition and nuptial-colour displacement as a diversifying force in Lake Victoria cichlid fishes. *Proc. R. Soc. Lond. B Biol. Sci.* **271**, 1345-1353.
- Servedio, M. R. and Noor, M. A. F.** (2003). The role of reinforcement in speciation: theory and data. *Annu. Rev. Ecol. Syst.* **34**, 339-364.
- Sokal, R. R. and Rohlf, F. J.** (1998). *Biometry: The Principles and Practice of Statistics in Biological Research*, 3rd edn. New York: W. H. Freeman & Co.
- Sullivan, J. P., Lavoué, S. and Hopkins, C. D.** (2000). Molecular systematics of the African electric fishes (Mormyroidea: Teleostei) and a model for the evolution of their electric organs. *J. Exp. Biol.* **203**, 665-683.
- Sullivan, J. P., Lavoué, S. and Hopkins, C. D.** (2002). Discovery and phylogenetic analysis of a riverine species flock of African electric fishes (Mormyridae: Teleostei). *Evolution* **56**, 597-616.
- Sullivan, J. P., Lavoué, S., Arnegard, M. E. and Hopkins, C. D.** (2004). AFLPs resolve phylogeny and reveal mitochondrial introgression within a species flock of African electric fish (Mormyroidea: Teleostei). *Evolution* **58**, 825-841.
- Svensson, E. I. and Sinervo, B.** (2004). Spatial scale and temporal component of selection in side-blotched lizards. *Am. Nat.* **163**, 726-734.
- Szabo, T. and Fessard, A.** (1974). Physiology of electroreceptors. In *Handbook of Sensory Physiology*, Vol. III/3. *Electroreceptors and Other Specialized Receptors in Lower Vertebrates* (ed. A. Fessard), pp. 59-124. Berlin: Springer-Verlag.
- Teysseire, C. and Serrier, J.** (1986). Temporal spacing of signals in communication, studied in weakly-electric mormyrid fish (Teleostei, Pisces). *Behav. Processes* **12**, 77-98.
- von der Emde, G.** (1999). Active electrolocation of objects in weakly electric fish. *J. Exp. Biol.* **202**, 1205-1215.
- West-Eberhard, M. J.** (2003). *Developmental Plasticity and Evolution*. New York: Oxford University Press.
- Wilczynski, W., Rand, A. S. and Ryan, M. J.** (2001). Evolution of calls and auditory tuning in the *Physalaemus pustulosus* species group. *Brain Behav. Evol.* **58**, 137-151.
- Wood, C. C. and Foote, C. J.** (1996). Evidence for sympatric genetic divergence of anadromous and nonanadromous morphs of sockeye salmon (*Oncorhynchus nerka*). *Evolution* **50**, 1265-1279.
- Xu-Friedman, M. A. and Hopkins, C. D.** (1999). Central mechanisms of temporal analysis in the knollenorgan pathway of mormyrid electric fish. *J. Exp. Biol.* **202**, 1311-1318.
- Zipser, B. and Bennett, M. V. L.** (1976). Interaction of electrosensory and electromotor signals in lateral line lobe of a mormyrid fish. *J. Neurophysiol.* **39**, 713-721.